

# DT690

## BusinessPhone Communication Platform

### USER GUIDE



## **Copyright**

© Copyright Aastra Telecom Sweden AB 2008. All rights reserved.

## **Disclaimer**

No parts of this publication may be reproduced, stored in retrieval systems, or transmitted in any form or by any means, electronic, mechanical, photocopying, recording or otherwise, without prior written permission of the publisher except in accordance with the following terms.

When this publication is made available on Aastra media, Aastra gives its consent to downloading and printing copies of the content provided in this file only for private use and not for redistribution. No parts of this publication may be subject to alteration, modification or commercial use. Aastra will not be liable for any damages arising from use of an illegal modified or altered publication.

# Contents

<b>1</b>	<b>Welcome</b>	<b>1</b>
<b>2</b>	<b>Important User Information</b>	<b>3</b>
2.1	Safety Instructions	5
2.2	Intrinsic Safety	10
2.3	Preparing for Use	10
2.4	IPEI Code	10
2.5	Accessibility and Voice Quality	10
2.6	System Version	11
<b>3</b>	<b>Description</b>	<b>13</b>
3.1	Functions and Accessories	14
3.2	Display Information	16
3.3	Menu Structure	21
3.4	Tones	27
<b>4</b>	<b>Switching On and Off</b>	<b>29</b>
4.1	Switching on	29
4.2	Switching off	29
<b>5</b>	<b>Contacts</b>	<b>31</b>
5.1	Call contact	31
5.2	Add contact	31
5.3	Edit contact	32
5.4	Delete Contact	32
5.5	Central Phonebook	32
5.6	Write Text	33
<b>6</b>	<b>Short cuts</b>	<b>35</b>
6.1	Defining Soft Keys	35
6.2	Defining Hot Keys	35
6.3	Defining Navigation Keys	36
6.4	Defining Multi-function button	36
<b>7</b>	<b>Incoming Calls</b>	<b>37</b>
7.1	Answering Calls	37

<b>8</b>	<b>Outgoing Calls</b>	<b>41</b>
8.1	Make Calls	41
8.2	Last External Number Re-dial	42
8.3	Dialling a Number from the Call List	42
8.4	Automatic Callback	42
8.5	Busy Extension	43
8.6	Call Statistics	43
<b>9</b>	<b>During Calls</b>	<b>45</b>
9.1	Inquiry	45
9.2	Dialling during a call	45
9.3	Transfer	46
9.4	Conference	46
9.5	Loudspeaking (Handsfree)	47
9.6	Mute Microphone	47
9.7	Call Waiting	47
9.8	Send a Message	48
<b>10</b>	<b>Call Forwarding</b>	<b>49</b>
10.1	Diversion when there is No Answer	49
10.2	Diversion when your Extension is Busy	49
10.3	Diversion when your Cordless is Switched off or out of Coverage	49
10.4	Fixed Diversion	49
10.5	Diversion when Charging	50
10.6	Individual Diversion	51
10.7	Bypass Call Forwarding	52
<b>11</b>	<b>Absence Information</b>	<b>53</b>
11.1	Enter Information	53
11.2	Erase Information, Save Information	55
<b>12</b>	<b>Mailbox System</b>	<b>57</b>
12.1	Activate the Mailbox	57
12.2	Deactivate the Mailbox	57
12.3	Access the Mailbox	57
12.4	Listen to your Messages	58
12.5	Change your Personal Greeting	59
12.6	Send Messages through your Mailbox	60

12.7	Outcall (External) Notification	60
12.8	Change Password	61
12.9	Dictaphone Function	62
12.10	Text Messages (optional)	63
<b>13</b>	<b>Abbreviated numbers</b>	<b>65</b>
13.1	Common Abbreviated Numbers	65
13.2	Individual Abbreviated Numbers	65
<b>14</b>	<b>Group Features</b>	<b>67</b>
14.1	Group Hunting	67
14.2	Group Call-pick-up	68
14.3	Common Bell Group	69
<b>15</b>	<b>Other Useful Features</b>	<b>71</b>
15.1	Automated Attendant	71
15.2	Doorphone	71
15.3	Account Number	71
15.4	Direct Inward System Access (DISA)	72
15.5	Tandem Configuration	73
15.6	Networking	74
15.7	IP calls	74
15.8	Key lock	74
<b>16</b>	<b>Security</b>	<b>77</b>
16.1	Phone Lock	77
16.2	Block Extension	78
16.3	Bypass Blocked Extension	78
<b>17</b>	<b>Least Cost Routing</b>	<b>81</b>
17.1	Use Least Cost Routing	81
17.2	Calling Least Cost Routing	81
<b>18</b>	<b>Settings</b>	<b>83</b>
18.1	Sound & Alerts	83
18.2	Display Brightness	85
18.3	Time and Date Settings	86
18.4	Changing Answering Methods	87
18.5	Modifying the Size of Messages	88
18.6	Language	88

<b>19</b>	<b>Useful Hints</b>	<b>91</b>
<b>20</b>	<b>Installation</b>	<b>93</b>
20.1	Check for completeness	93
20.2	Battery	93
20.3	Desktop Charger	94
20.4	Rack Charger	96
20.5	Battery Pack Charger	96
20.6	Headset	96
20.7	Hinge-type Clip	96
20.8	Swivel-type Clip	96
20.9	Portable Device Manager	97
<b>21</b>	<b>Reference</b>	<b>99</b>
21.1	Terminology	99
21.2	Phone Signals	99
21.3	Maintenance	100
21.4	Technical Specifications	100
21.5	Spare parts and Accessories	105
<b>22</b>	<b>Troubleshooting</b>	<b>107</b>
<b>23</b>	<b>Glossary</b>	<b>111</b>
<b>24</b>	<b>Telephony Function Codes</b>	<b>113</b>

# 1 Welcome

Welcome to the user guide for the DT690 cordless phone. This guide describes the available features of the telephone when it is connected to BusinessPhone Communication Platform from Aastra. The BusinessPhone Communication Platform consists of BusinessPhone Compact, BusinessPhone 50, BusinessPhone 128i and BusinessPhone 250.

The features described in this User Guide are related to version 7.0 or higher of the BusinessPhone Communication Platform. Some might not work in earlier versions of the system and/or might be protected by a license package that has to be bought separately.

The User Guide describes the facilities of the BusinessPhone Communication Platform and the DT690 cordless phone with a default programming. There may be some differences in the way your phone is programmed.

Please consult your system administrator if you need further information.

<http://www.aastra.com>.



## 2 Important User Information

### **WARRANTY**

AASTRA MAKES NO WARRANTY OF ANY KIND WITH REGARD TO THIS MATERIAL, INCLUDING, BUT NOT LIMITED TO, THE IMPLIED WARRANTIES OF MERCHANTABILITY AND FITNESS FOR A PARTICULAR PURPOSE. Aastra shall not be liable for errors contained herein nor for incidental or consequential damages in connection with the furnishing, performance or use of this material.

### **TRADEMARK**

Aastra is a registered trademark of Aastra Technologies Limited. All other trademarks mentioned herein are the property of their respective owners.

### **DECLARATION OF CONFORMITY**

Hereby, Aastra Telecom Sweden AB, SE-126 37 Hägersten, declares that this telephone, is in conformity with the essential requirements and other relevant pros of the European R&TTE directive 1999/5/EC. Details to be found at: <http://www.aastra.com>.



### **FCC Statement**

This equipment has been tested and found to comply with the limits for a Class B digital device, pursuant to Part 15 of the FCC rules.

These limits are designed to provide reasonable protection against harmful interference in a residential installation. This equipment generates, uses and can radiate radio frequency energy and, if not installed and used in accordance with the instructions, may cause harmful interference to radio communications.

However, there is no guarantee that interference will not occur in a particular installation. If this equipment does cause harmful interference to radio or television reception, which can be determined by turning the equipment off and on, the user is encouraged to try to correct the interference by one or more of the following measures:

- Reorient or relocate the receiving antenna.
- Increase the separation between the equipment and receiver.
- Connect the equipment into an outlet on a circuit different from that to which the receiver is connected

- Consult the dealer or an experienced radio/TV technician for help.

Privacy of communications may not be ensured when using this phone.

This equipment complies with FCC radiation exposure limits set forth for an uncontrolled environment. This device complies with FCC SAR limit of 1.6 W/kg. The maximum SAR value measured when used at the ear is 0.104 W/kg. The telephone has also been tested when worn on the body using belt clip, maximum measured SAR value in this configuration is 0.037 W/kg. This device must not be collocated or operating in conjunction with any other antenna or transmitter.

- This equipment complies with Part 68 of the FCC rules and the requirements adopted by the ACTA. On the rear side, underneath the battery of this equipment is a label that contains, among other information, a product identifier in the format US:AAAEQ##TXXXX. If requested, this number must be provided to the telephone company.
- REN is N/A as this product is intended to be connected behind a FCC Part 68 compliant PBX system. It is not intended for direct connection to telephone network.
- If this equipment cause harm to the telephone network, the telephone company will notify you in advance that temporary discontinuance of service may be required. But if advance notice isn't practical, the telephone company will notify the customer as soon as possible. Also, you will be advised of your right to file a complaint with the FCC if you believe it is necessary.
- The telephone company may make changes in its facilities, equipment, operations or procedures that could affect the operation of the equipment. If this happens, the telephone company will provide advance notice in order for you to make necessary modifications to maintain uninterrupted service.
- If trouble is experienced with this equipment, for repair or warranty information, please contact your Aastra business partner <http://www.aastra.com>. This equipment is not intended to be repaired by the customer (user). If the equipment is causing harm to the telephone network, the telephone company may request that you disconnect the equipment until the problem is resolved.
- Connection to party line service is subject to state tariffs. Contact the state public utility commission, public service commission or corporation commission for information.
- If your home has specially wired alarm equipment connected to the telephone line, ensure the installation of this equipment that it does not disable your alarm equipment. If you have questions about what will disable alarm equipment, consult your telephone company or qualified installer.



*Electrical Safety Advisory*

Electrical surges, typically lightning transients, are very destructive to customer terminal equipment connected to AC power sources. Customer is thus recommended to use a surge arrester for the equipment that requires AC power.

## 2.1 Safety Instructions

**Note:** When using your telephone or connected equipment, the following basic safety precautions should always be followed to reduce risk of fire, electrical shock and other personal injury.

### 2.1.1 Recommendations

- Always keep and handle your products with care and keep them in a clean and dust-free place. Proper use and care will prolong the products life. Use a soft absorbent tissue or cloth to remove dust, dirt or moisture.
- Always ensure that the phone, battery and charger are used and operated in the environment for which they are designed.
- Operate the phone in temperatures between 0°C to +40°C (32°F to 104°F).
-  Do not expose your products to liquid, moisture, humidity, solvents, strong sunlight, harsh environments or extreme temperatures, never above +60°C (+140°F), unless the product has been specifically designed and officially approved for such environments.
-  Exposure to heat may cause batteries to leak, overheat or explode, resulting in fire, burns or other injuries.
- Do not put the product in the microwave oven: This may cause damage to either the oven or the product.
-  Do not attempt to disassemble or alter any part of the phone, the charger(s) or the battery-pack. Disassembly or alteration may result in electrical shock or irreversible damage to the equipment. Only a qualified service personnel or an authorized Aastra partner should conduct internal inspections, alterations and repairs.
- Do not expose your product to open flames or lit tobacco products.
- Do not drop, throw or bend your products. This may cause malfunction or electric shock.
- Do not paint your product.
- Do not use your product in an area where a potentially explosive atmosphere exists, unless the product has been specifically designed and officially approved for such environments

- To avoid hearing impairment, accept the call before holding your product (or portable handsfree device) to your ear.

---

---

## **Warning!**

The handset may retain small magnetic objects around the mouthcap or earcap region. Please check and remove before use.

---

---

### **2.1.2 Disposal of the product**



Your product should not be placed in municipal waste. Please check local regulations for disposal of electronic products.

### **2.1.3 Power supply**

Available power adapters (Suppliers Designation) are:

- Art.No.DC3: 130160 Power supply unit AC/5V DC/0.65A -Europe
- Art.No.DC3: 130166 Power supply unit AC/5V DC/1A -USA, Canada, AUS, and U.K.
- Art.No.DC4: 130161 Power supply unit AC/5V DC/2A

#### **Precautions:**

- Connect the AC power supply to the desktop battery charger only to the designated power sources as marked on the charger.
- Make sure the AC power supply is positioned so that it will not be subjected to damage or stress.
- To reduce risk of electrical shock, unplug the chargers from any power source before attempting to clean or move it.
- The AC power adapters must not be used outdoors or in damp areas.
- Never modify the cord or plug. If the plug will not fit into the outlet, have a proper outlet installed by a qualified electrician.
- Limit the distance between the mains socket and the cordless phone when charging for easy accessibility.
- As an energy saving measure, disconnect the charger from the main socket after charging.

- When unplugging the mains adapter from the power outlet, make sure that your hands are dry and ensure that you hold the solid portion of the mains adapter.
- Do not pull on cables.

#### 2.1.4 Charging and batteries

This product should only be used with the following battery:

- Art.No.: 660190 Battery

Single chargers shall only be connected with power adapters supplied by the manufacturer, see list above.

##### **Precautions:**

Please read carefully the following important precautions before the first time use of the batteries. Make sure to understand and observe all cautionary instructions stated, so as to avoid any possible safety hazards that are caused by any misuse, misapplication or damage to batteries.

- Only use batteries, mains adapters or desk and rack chargers which have been specifically designed for use with your product.
- Use of power sources not explicitly recommended may lead to overheating, reduced battery performance, distortion of the equipment and fire or other damages.
- The phone is equipped with Li-Polymer/Li-Ion battery. In a complex infrastructure, the talk- and standby time may differ, due to the consequence of the increase in signaling.
- The battery must always be completely charged (minimal 4 hours) before first time use.
- The battery in your product is designed to withstand many charge cycles.
- Use only the recommended charging equipment.
- Improper charging can cause heat damage or even high pressure rupture.
- Observe proper charging polarity.
- Do not solder lead wires directly onto the battery.
- Do not allow water to come into contact with the battery, this could short-circuit and damage the battery.
- If the handset has been exposed for water or condense, remove the battery immediately and let it dry completely before reinserting the battery.

- Remove the battery before cleaning the telephone to reduce risk of electric shock.
- Unplug the battery charger from a power source before cleaning the handset to reduce risk of electric shock.
- The battery is replaceable, however it is not the intention to do this frequently.
- Only charge the battery when placed in the phone.
- Use only the specified battery-packs for your product.
- Never heat or dispose of the battery into a fire, which, or else, may cause leakage, burst or fire.
- Remove the carrying case from the product while in charger.
- Do not cover the product while being charged. Do not charge the phone in a closed cabinet or drawer. The charging of the battery is a chemical process and causes the battery to become warm during charging. Make sure the environment in which the phone is charged, is well vented.
- The cordless phone can be charged either when switched on or off.
- Do not connect the battery's positive and negative leads altogether in any circumstances.
- Do not strike or drop the battery. It may cause damage to the battery.
-  Do not charge the battery below +5°C (+41°F). Be sure to charge the battery between +5°C and +40°C (+41°F and 104°F). Charging beyond these conditions may impair the battery performance and shorten the life cycle.
- Do not use battery packs from different types, brands or of different capacities.
- The battery is to be stored in a dry cool place, with the ambient temperature of approximately +25°C (+77°F) for best performance.
- The battery continues to discharge a minimal portion of its power, even if the product is switched off or the battery is removed.
- Dispose the battery in accordance with all local regulations, applicable in your country.

---

---

## Warning!

*Smoke or fumes*



Stop operating the products and turn off immediately in case of smoke or fumes. Unplug the mains adapter and remove the batteries from the phone immediately. Continued operation may result in fire or electrical shock.

---

---

---

---

## Warning!

*LCD*

If the liquid crystal display breaks, avoid injury by not allowing the liquid crystal to come into contact with eyes, skin or mouth. Prevent the liquid crystal from leaking out of the broken glass.

---

---

### 2.1.5 Bluetooth Qualified Design ID

Bluetooth QD ID: B014317

### 2.1.6 Preventing malfunction

- Never place the equipment in close proximity of electric motors, welding equipment or other devices generating strong (electro) magnetic fields. Exposure to strong (electro) magnetic fields may cause malfunction and corrupt the communication.
- Moving the equipment rapidly between warm and cold temperatures may cause condensation (water droplets) to form on its internal and external surfaces. Water droplets may cause malfunction of the equipment and corrupt or end communication or damage the equipment. When condensation is noticed, stop using the equipment. Switch off the phone, remove the battery and unplug the mains adapter from the power outlet. Wait until the moisture evaporates from the equipment before putting it in operation again.
- Avoid accidental drop of the phone. Use the clip, security clip or carrying case specified for carrying purposes of the phone.
- Avoid squeezing the phone between furniture and your body when carrying the phone in your pocket or attached to clothing.

## 2.2 Intrinsic Safety

The DT390 phone is not specified as intrinsically safe, so do not use it in areas with a danger of explosion.

## 2.3 Preparing for Use

Before using your phone for the first time, you have charge and connect the battery, see Section 20.2 on page 93.

**Note:** Place the phone in the charger and charge it for at least one hour before using it the first time.

## 2.4 IPEI Code

Your phone has an International Portable part Equipment Identity (IPEI) code. This code is unique for each phone, and it is needed for your system administrator to enable network subscription of your phone. It is also needed if the user has entered the wrong phone lock code three times.

To look up the IPEI code, do the following:

- Enter **\*#06#** when phone is in idle mode.  
A message box with the text **IPEI** followed by the IPEI number (13 digits) is shown.
  - If the phone lock is on, **Enter PIN code** is shown.
  - Enter the PIN code.

**Note:** Write down the IPEI code for future use. If you cannot retrieve the IPEI code, please contact your system administrator. Keep the IPEI code secret to prevent misuse of your phone.

## 2.5 Accessibility and Voice Quality

The base network is not always available. If you do not get in contact with your system, contact your system administrator. For best voice quality, avoid positioning near computer, radio or similar equipment.

### 2.5.1 Operating area

You can use your cordless telephone in the area that is covered by the network. Outside this area you will lose contact with the telephone network. The signal strength icon, will disappear and **No network** will be displayed.

## 2.5.2 Out of Range

When you leave the system coverage area you will hear a short beep and see a lamp indication, and the text *Searching* will appear in the display. The out of range beep will be repeated every minute for 30 minutes. When reentering the coverage area it can take a couple of minutes before the phone automatically has registered into the system.

## 2.5.3 Frequency Range

The handset is a radio transmitter and receiver. When it is on, it receives and sends out radio frequency (RF) energy. The handset operates on different frequency ranges depending on market and employs commonly used modulation techniques:

- EU 1880 - 1900 MHz
- U.S. 1920 - 1930 MHz
- L.A. 1910 - 1930 MHz

## 2.6 System Version

To view the telephone's software version:

- Enter **\*#34#** in standby mode.



## 3 Description

This section describes the DT690 and its display information, menu structure, and tones. A picture of the telephone is shown in Figure 1 on page 13.

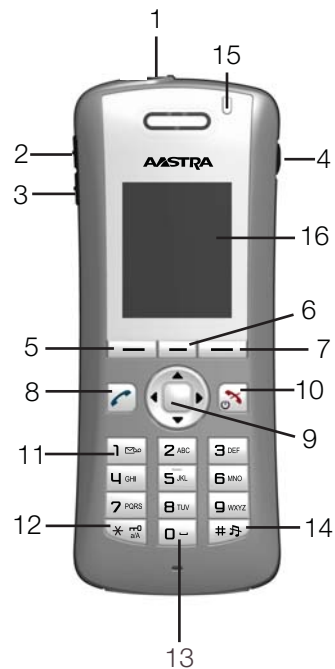

Figure 1 Overview of the cordless telephone DT690

- 1 Multifunction button**  
This button can be used as a short cut to functions; long or double press modes.
- 2 Volume Up**  
To increase the speaker volume.
- 3 Volume Down**  
To decrease the speaker volume.
- 4 Headset connector**  
The headset connector is for connecting a headset. The connector is protected against dust by using the headset connector cover.
- 5 Left Soft key<sup>(1)</sup>**  
Can be pre-programmed or used with GUI.
- 6 Middle Soft key**  
Can be pre-programmed or used with GUI.

- 7 Right Soft key**  
Can be pre-programmed or used with GUI.
- 8 Hook-off**  
To answer a call, to pre-dial a number, and as a short cut to the Call list.
- 9 Five-way navigation key**  
Navigation key with Left, Right, Up, Down, and Confirmation (in the middle). The navigation key can be programmed, the Up is by default a short cut to the Inbox, and Down is a short cut to Call contact. During a call it is possible to increase/decrease the volume by pressing Up and Down. The middle key is for confirmation and in standby mode it is by default a short cut to the main menu.
- 10 Hook-on; Power on/off**  
Combined button; to end a call, to return to standby mode, and to switch the handset on/off by long press.
- 11 Voice mail access**  
To listen to a voice mail.
- 12 Key lock and Upper/Lower case**  
Combined key lock and Upper/Lower Case.
- 13 Space**  
To add space between text.
- 14 Mute**  
Turn off/on audible signals in idle mode, silencing the ring signal at incoming call, and also to turn the microphone on/off during a call.
- 15 LED**  
Indicates incoming call, messaging, low battery, and charging.
- 16 Display**  
The full graphic type display is 128 pixels wide and 160 pixels high. The display has multiple colours and backlighting.

*(1) Soft keys are explained further in Figure 4 on page 17*

## 3.1 Functions and Accessories

The following section lists the functions and accessories available for the DT690 phone. See Figure 2 on page 15 for the complete list.

Functions	DT690
Local phonebook (250 contacts)	Yes
Central phonebook	Yes*
Vibrator	Yes
Headset connector	Yes
Microphone on/off during call	Yes
Loudspeaking function	Yes
SMS (Short Message Service)	Yes*
Voice mail access	Yes*
Centralized Management	Yes*
Easy replaceable battery	Yes
Bluetooth (optional)	Yes

Accessories	
Desktop charger Basic	Yes
Desktop charger Advanced	Yes
Charging rack	Yes
Battery pack charger	Yes
Leather case	Yes
Belt Clip	
hinge-type	Yes
swivel-type	Yes
Security chain	Yes
Headset with microphone on boom	Yes
Headset with microphone on cable	Yes
Bluetooth Headset	Yes
CPDM	Yes
PDM Windows Version	Yes

\* System dependent

100

**Figure 2** DT690 functions and accessories

<b>Case</b>	The plastic cover parts are made of durable PC/ABS material.
<b>Antenna</b>	The antenna is integrated inside the phone.
<b>Loudspeaker</b>	The cordless telephone has a separate loudspeaker for the loudspeaking function. It is placed on the back side of the cordless telephone.
<b>Microphone</b>	The microphone is placed on the front bottom side of the phone.
<b>Clip</b>	There are three different belt clip options to the cordless telephone; a hinge-type clip (standard), a swivel-type clip, or no clip which makes it possible to use the

cordless telephone without any clip on. Use the clip to attach the phone to a belt or similar.

**Battery**

The battery is a rechargeable Li-Pol/Li-Ion battery, placed under a battery cover. The battery is fully charged within four hours. The battery can be charged separately with a special battery charger.

**Headset**

A headset is recommended if you frequently use the phone or want to have both hands free. The handset has a special headset connector that is waterproof. The headset comes in three versions; with microphone integrated in the cable, with microphone on a boom and with hearing protection (Peltor). An adapter, that makes it possible to connect other standard types of Peltor headsets, is also available.

In order to achieve optimal audio quality with the different headset types it is recommended that the SIM parameter called Headset type is altered to match the headset type being used. The default setting for this parameter is microphone on a boom, that is, the audio is optimized for using a headset with microphone on a boom.

### 3.2 Display Information

All functions and settings available to the user are shown as icons and text in the display. The icons and text in the display indicate functions and settings available to the user. The display gives visual feedback on all actions performed, and also textual warnings, see Figure 3 on page 16. The owner ID can manually be set by the user.

**Note:** If a name is available it is displayed instead of, or together with, the number.

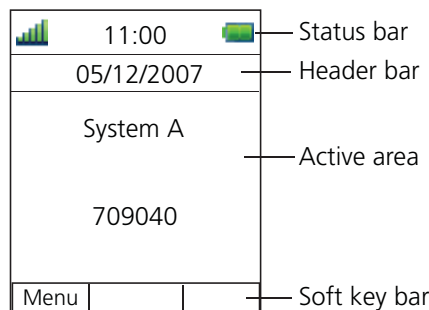

004

Figure 3 Display configuration in standby mode

**Status bar**

The top row is used for icons giving the user information for signal strength, missed call, new message, time and battery status. This row is always visible.

### Header bar

The next row displays the current date, headset connection, Bluetooth connection, phone lock, and so on.

### Text field

The next rows (Active area) are used for information such as the name of the system to which the cordless telephone is connected to. A user identity provided from the system and/or an Owner ID can also be displayed if configured in the Settings menu. This is also the area for pop up text for example, missed calls or to confirm an action. The network name, for example System A, as in Figure 3 on page 16, indicates that the system is in contact with system A.

### Soft key bar

The bottom row is used for soft keys which can be used as short cuts for functions in the telephone. There are three soft keys, located just beneath the display and the functions of each soft key is indicated by text in the display just above the keys, see Figure 4 on page 17. In standby mode, the soft keys can be used for specific functions defined by the user of the handset.

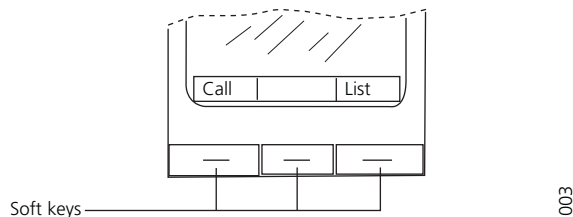

Figure 4 Soft key Call and soft key List

**Note:** The information displayed varies depending on the version and configuration of the exchange, and whether you use a DECT or an IP DECT phone. Consult your system administrator to find out which type of phone you have.

Depending on the state and setting of your phone, different information can be shown, see the following list:

- **Idle phone**
  - Normal  
The display shows the programmed name of your network, your name and extension number, time, date, and so on, see Figure 3 on page 16.
  - Follow-me activated  
The display shows your own extension number followed by a > and the extension number diverted to.
- **Outgoing call**

- Normal outgoing call  
When making an outgoing call, the dialled number or name is displayed.
- Diverted call  
When the diverted call is answered, only the number of the answering position is displayed.
- **Incoming call**
  - Normal incoming call  
If available, the number or the name of the caller is displayed.
  - Diverted call  
When you have answered the call, the display only shows the number of the person calling.

### 3.2.1 System Connection Messages



Possible system connection messages that can be displayed on your phone is described below.

















Shown in display	Indicating	Description
<i>No System</i>	Out of coverage	The phone is not in contact with any other system. Please ask your system administrator to log on the phone. <sup>(1)</sup>
<i>No access</i>	Access Indication	Your phone has contact with a system, calling is not allowed.

*(1) When reentering the coverage area it can take a couple of minutes before the phone automatically has registered into the system.*

### 3.2.2 Display Icons

The display icons are listed and shortly described below.

Icon	Description
	<b>Signal strength</b> Shown when the phone is connected to a system.
	<b>Sound off</b> Shown when the Mute key is pressed at idle mode and turn off ringing sound.
	<b>Battery</b> Always shown in the display in standby mode. When the level is low, it is time to charge the battery. See Section 20 on page 93.

Icon	Description
	<p><b>Low battery</b> Shown when the battery only has 10% of its capacity left. The icon is flashing when the battery capacity is equal to, or lower than 5%.</p>
	<p><b>Loudspeaking</b> Shown when the loudspeaker is activated.</p>
	<p><b>Loudspeaking off</b> This icon is displayed and used to deactivate the loudspeaker.</p>
	<p><b>Microphone off</b> Shown when the microphone is off.</p>
	<p><b>New message</b> Indicates that a new text message (or messages) has arrived. The icon remains in the display until all new messages in the inbox are read.</p>
	<p><b>Voice message</b> Appears when a voice message is waiting.</p>
	<p><b>Read message</b> Placed in front of a message indicates that this message already has been read.</p>
	<p><b>Key lock</b> Indicates a locked keypad. See Section 18 on page 83.</p>
	<p><b>Phone lock</b> Indicates a locked phone.</p>
	<p><b>Bluetooth</b> Indicates that Bluetooth is enabled.</p>
	<p><b>Bluetooth headset</b> Indicates that a Bluetooth headset is connected to the phone.</p>
	<p><b>Headset</b> Indicates that a headset is connected to the phone. See Section 20.6 on page 96.</p>
	<p><b>Outgoing call</b> Added in front of outgoing calls in the Call list.</p>
	<p><b>Incoming call</b> Added in front of all answered calls in the Call list.</p>
	<p><b>Missed call</b> Added in front of missed calls in the Call list.</p>
	<p><b>System connection</b> Visible when connecting to a system.</p>

### 3.2.3 Menu Tabs

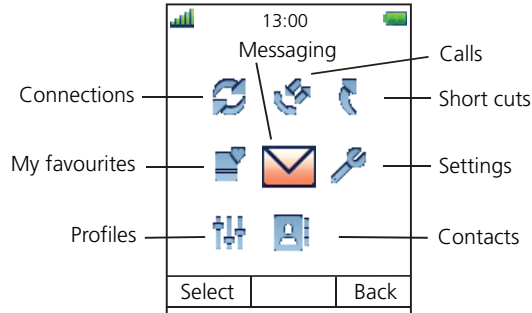

The menu tabs are listed and described below.



#### **Contacts**

Contains all names and numbers in the personal phonebook. It is also possible to access a central phonebook from this menu<sup>(1)</sup>.



#### **My Favourites**

Contains menu short cuts used to customized a menu.



#### **Messaging**

Contains all message handling such as reading, writing, and sending messages.



#### **Calls**

Contains call lists, call time, and call services..



#### **Connections**

Contains Bluetooth connection, as well as Headset, System, and In charger functions.



#### **Settings**

Contains short cuts for the soft keys, hot keys and navigation keys, as well as personal phone settings. See Section 18 on page 83.



#### **Shortcuts**

Contain Soft keys, Hot keys and Navigation keys configuration.



#### **Profiles**

Contains a normal editable profile, and possibility to add four other different profiles.

*(1) This menu function requires that the corresponding code has been downloaded to your phone using the PC program Cordless Phone Manager. Please contact your system administrator.*

### 3.2.4 Additional Display Features

Depending on which network you are connected to, additional display features are available. Ask your system administrator if you require additional display features.

## 3.3 Menu Structure

The available phone and network functions can be accessed through the

menus. Press  to enter the menus.

**Note:** The phone can be used in several networks, and it is not sure that all functions are supported in all networks.

### 3.3.1 Calls Tab

An overview of the **Calls** tab  is presented in Figure 5 on page 21.

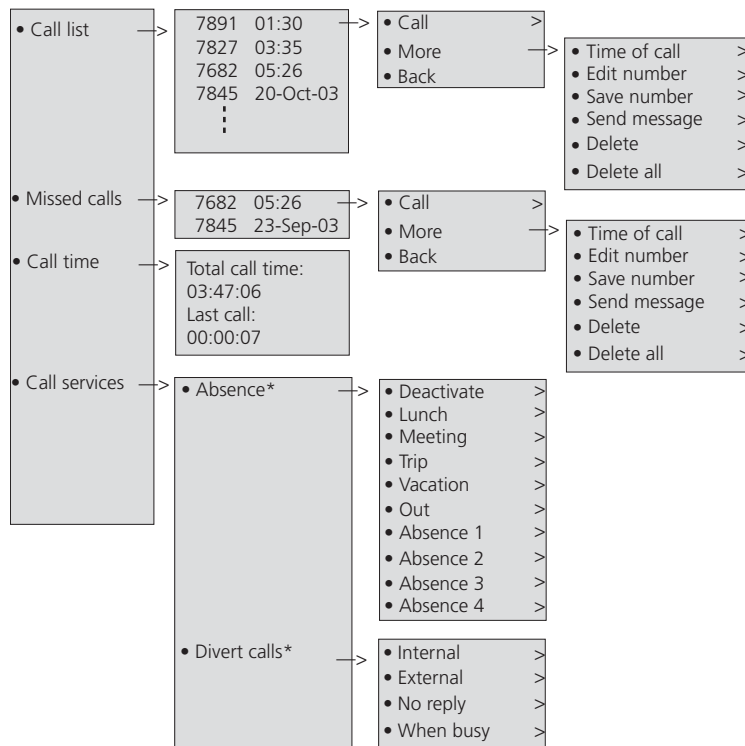

\* Visible if defined in the PDM

Figure 5 Calls structure

### 3.3.2 Contacts Tab

An overview of the **Contacts** tab  is presented in Figure 6 on page 22.

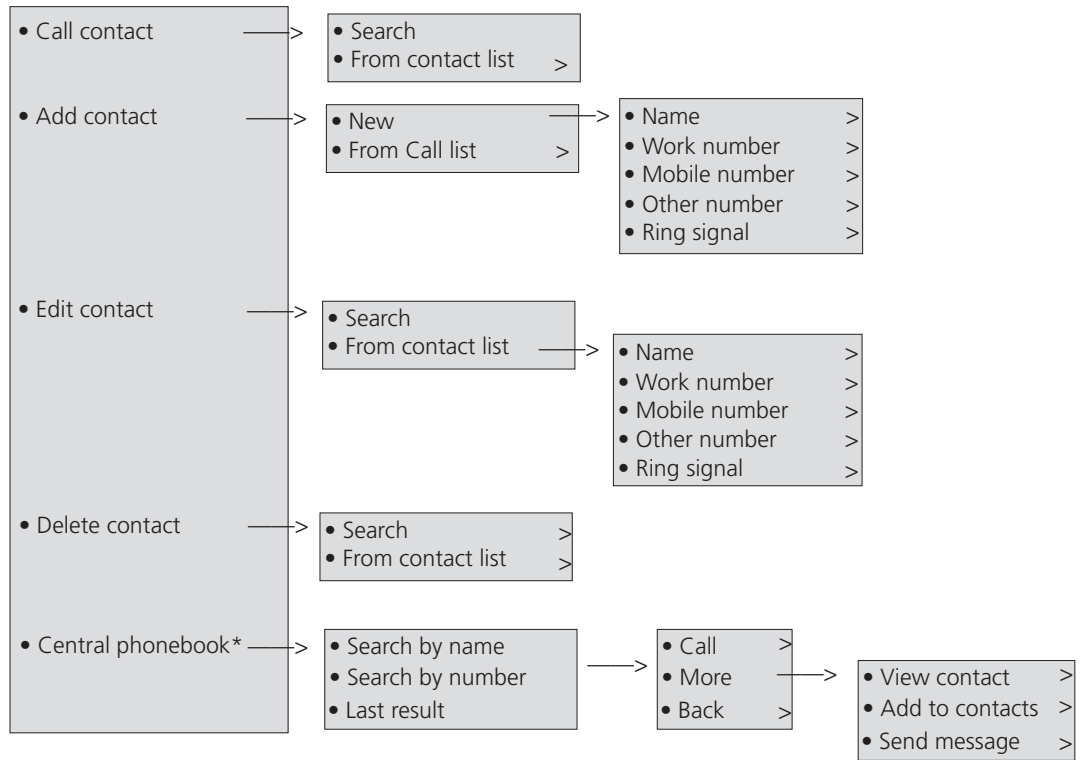

\* System dependent

Figure 6 Contacts structure

### 3.3.3

### Profile Tab

An overview of the **Profile** tab  is presented in Figure 7 on page 22.

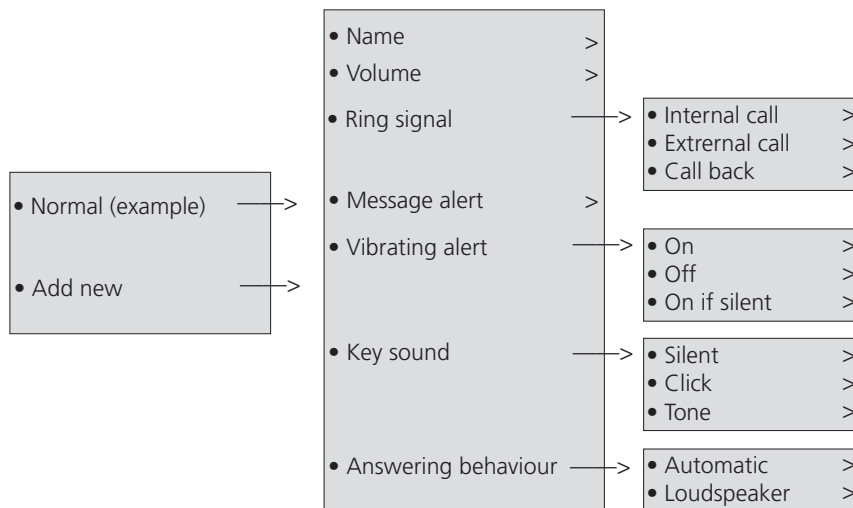

Figure 7 Profile structure



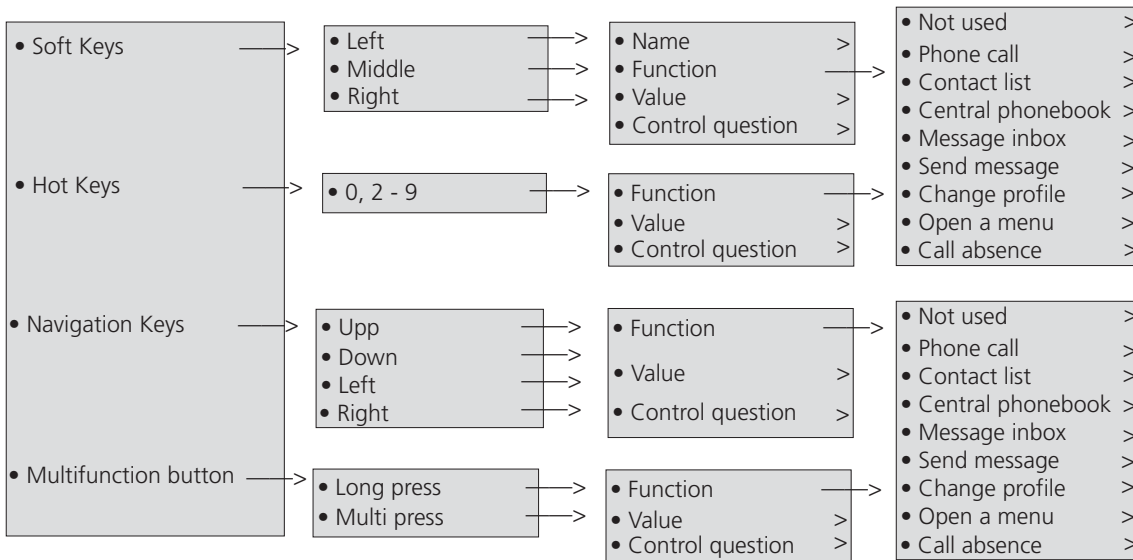

Figure 9 Short cuts structure

### 3.3.6 Connection Tab

An overview of the **Connection** tab  is presented in Figure 10 on page 24.

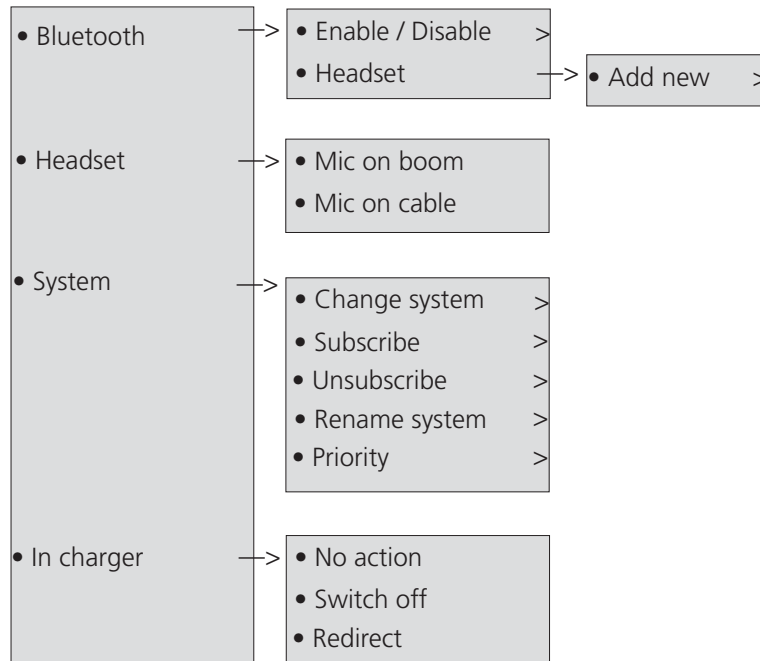

Figure 10 Connection structure

### 3.3.7

## Settings Tab

An overview of the **Settings** tab  is presented in Figure 11 on page 25.

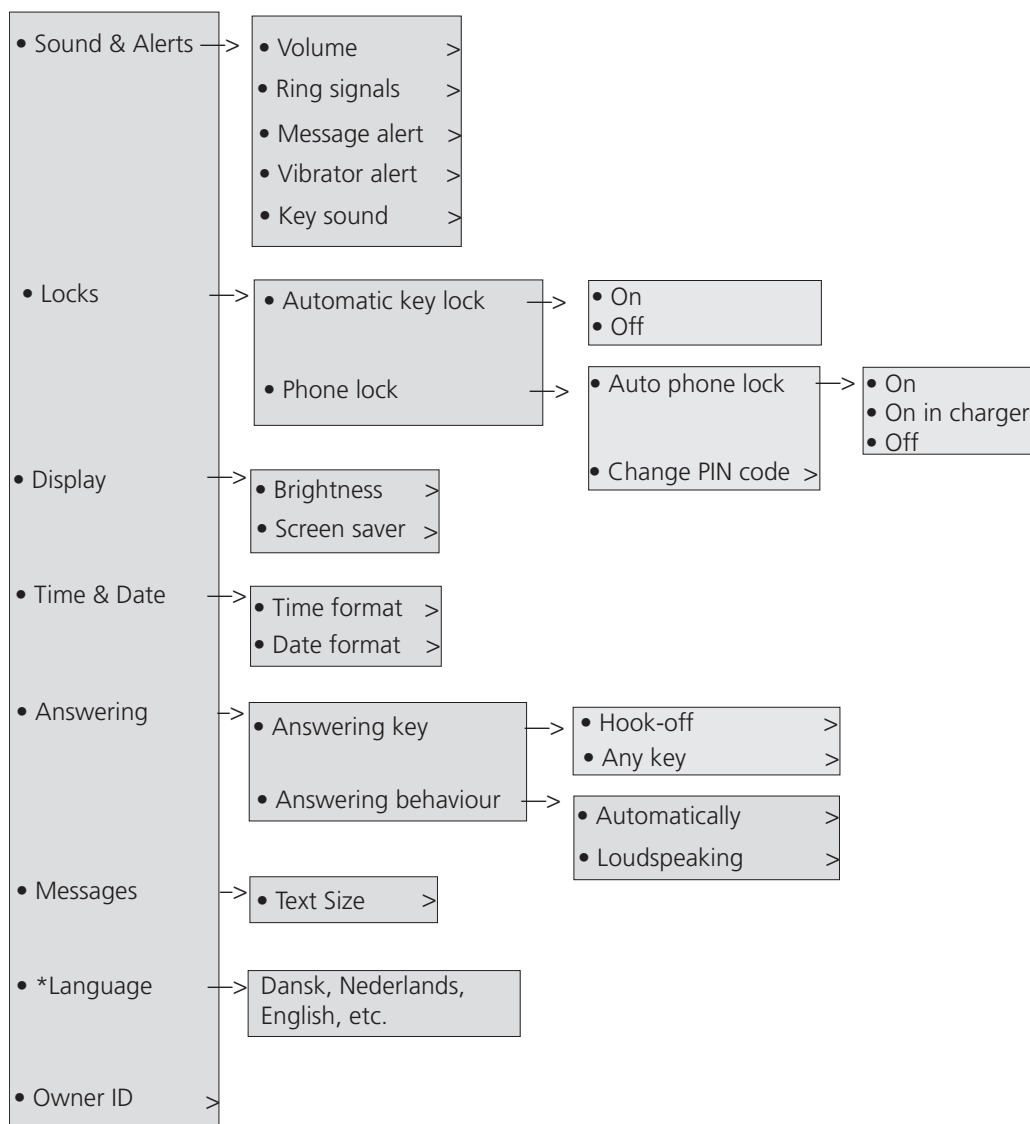
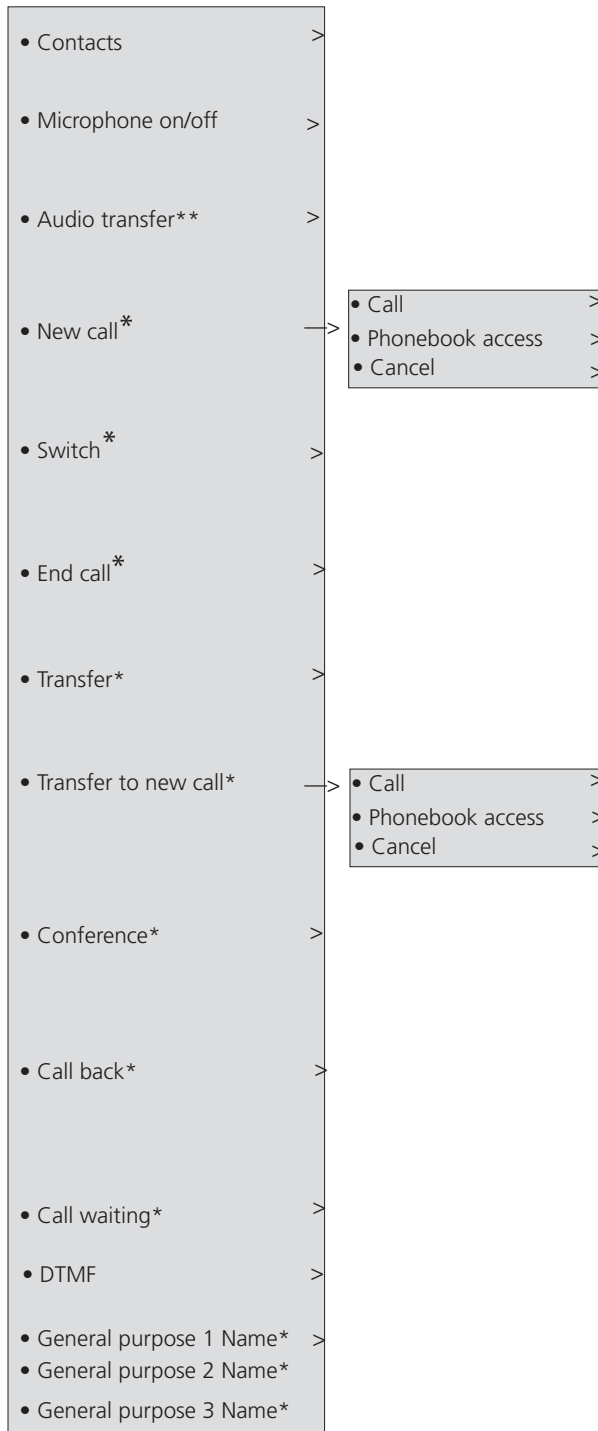

Figure 11 Settings structure

### 3.3.8

## In Call Tab

The **In Call** tab is reached during a call from the middle soft key **More**. See overview in Figure 12 on page 26.













\*\*Only available when Bluetooth connection is active.

\* Visible if defined in the PDM

**Figure 12** *In Call*

## 3.4 Tones

The following different tones are sent from the exchange to your phone.

Dial tone	
Special dial tone	
Ringing tone or queue tone	
Busy tone	
Congestion tone	
Number unobtainable tone	
Call waiting tone	
Intrusion tone	
Conference tone	 Every 15 seconds (to all parties)
Verification tone	
Warning tone, expensive route	



## 4 Switching On and Off

This section describes how to switch on and off the telephone.

**Note:** If the message **No System** is displayed you cannot make or answer calls. Depending on system programming, your phone can be automatically locked. To unlock the phone, enter your four-digit code (factory default is "0000").

### 4.1 Switching on

To switch on the telephone:

1. Press and hold .
2. Press **Yes**.

After a few seconds, the display turns blank. Now your phone is switched on.

### 4.2 Switching off

To switch off the telephone:

1. Press and hold .
2. Press **Yes**.



After a few seconds, the display turns blank. Now your phone is switched off.



## 5 Contacts

This section describes how to configure the **Contacts** menu.



1. Press the **Menu**, or the confirmation button on .
2. Select .

There is a default ring signal to each number. The ring signal can be changed by selecting **Ring signal** in edit mode.

### 5.1 Call contact

1. Select **Call contact**.
2. Select a contact from the list, or enter name or number in the search field.
3. Press **Call**.

### 5.2 Add contact

To add a contact:

1. Select **Add contact**.
2. Select **New**.
3. Select **Add**, and enter the name of the contact.
4. Select **OK**.
5. Add the **Office Number**, **Mobile number** and **Home number**.
6. Press **OK**.
7. Press **Save** to save the settings.

Different ring signals can be set to distinguish for example, work number and mobile number.

#### **Add from Call list**

1. Select **From Call list**.
2. Select a number.

3. Press **Add**.
4. Select the number type.
5. Press **Select**.
6. Press **Add** and enter the name of the contact.
7. Press **OK**.
8. Press **Save**.

### 5.3 Edit contact

1. Select **Edit contact**.
2. Select the contact and press **Edit** twice.
3. Select **Name** and press **OK**.
4. Press **Save**.

### 5.4 Delete Contact

1. Select **Delete contact**.
2. Select the contact, and press **Delete**.
3. Press **Yes** to confirm.

### 5.5 Central Phonebook

The Central phonebook allows you to search by name, number, or the latest result. When the search result is ready, it is possible to view contact information, add the number to new contact, and to send a message by selecting **More**.

You can also call the number by selecting **Call**.

#### **Search by name**

1. Select **Central Phonebook**.
2. Select **Search by name**.
3. Enter **First name** and/or **Last name**.
4. Select **Search**.

The search result will be displayed.

#### **Search by number**

1. Select **Search by number**.

2. Enter the phone number and select **Search**.

The search result is displayed.

### **Last result**

Select **Last result** to display the last result only.

## 5.6 Write Text

When writing text messages and adding/editing or searching for names in the Phonebook, the keys 0 to 9, \*, or # can be used. The first character entered will be an upper level character followed by lower level characters unless the \*-key is pressed before entering the character.

When pressing a key, the first available character on that specific key is displayed. To get the following characters, press the key repeatedly. Key 0 and 1 contain special characters. The marked character is selected after a time-out (3 seconds) or when another key is pressed.

Pressing key 1 adds space between the characters and pressing the \*-key switches between upper and lower case (not applicable in the System Phonebook). The first character entered in a message, or when adding/editing a name in the phonebook, will be an upper level character followed by lower level characters unless the \*-key is pressed before entering the character.

Example (to write Smith):

7 7 7 7 Press for S.

6 Press for m.

4 4 4 Press for i.

8 Press for t.

4 4 Press for h.

*Example 1*

### **Control keys**

While entering a name or a number, you can use the following keys for control and navigation:

1. Press the left navigation key to move to the left.

**Note:** Moves to the beginning of the text if held longer.

2. Press the right navigation key to move to the right.

**Note:** Moves to the end of the text if held longer.

3. Press \* to switch between upper and lower case.

**Note:** Pressed for more than one second will add a dial tone pause.

4. Press **1** to enter a space.
5. Press **Clear** to correct a wrong entry.

**Special characters**

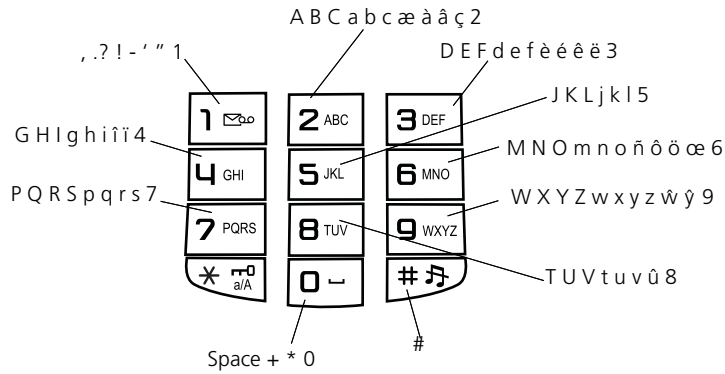

006

*Figure 13 Available characters*

**Note:** Depending on the selected menu language, other characters can be available. This means that the character order can differ from the table above.

## 6 Short cuts

This section explains how the predefined functions can be set as short cuts for the **Soft keys**, **Hot keys**, **Navigation keys**, and the **Multi-function button**.

It is for example possible to define the soft key to make a call or as a short cut to send a message.

### 6.1 Defining Soft Keys

To define soft keys:

1. Press **Menu** and navigate to **Short cuts**.
2. Select **Soft keys**.
3. Choose between **Left**, **Middle**, or **Right** and press **Select** to confirm.
4. Select **Name** and enter the name of the soft key.
5. Press **OK** to save the setting.
6. Select **Function**, and press **Select** to choose the function for the soft key.
7. Select the function from the list, and press **Back**.
8. Select **Value** (only for some of the functions) and press **Edit**.
9. Enter a value (for example a telephone number), and press **Back**.
10. Navigate to **Control question**, and press **Select**.

**Note:** By default, the value is **Off**.

### 6.2 Defining Hot Keys

A Hot key can be programmed to give access to frequently used functions such as dialling a specific telephone number, a shortcut on the menu, or sending an SMS. Any key "0", "2" - "9" can be set to a Hot Key. A long press on any of these digits in stand by mode are by default a shortcut to the Call contact list.

To define hot keys:

1. Select **Hot keys**.
2. Select **0** to **9**.
3. Select **Function**, and press **Select** to select the function for the soft key.

4. Select the function from the list, and press **Back**.
5. Navigate to **Control question**, and press **Select**.

**Note:** By default, the value is **Off**.

## 6.3 Defining Navigation Keys

To define navigation keys:

1. Select **Navigation keys**.
2. Select **Up, Down, Left, or Right**.
3. Press **Select** to enter a name for the Soft key.
4. Select **Function**, and press **Select** to select the function for the soft key.
5. Select the function from the list, and press **Back**.
6. Select **Control question**, and press **Select**.
7. Select either **Off** or **On** and press **Back** to save the setting.

**Note:** By default, the value is **Off**.

## 6.4 Defining Multi-function button

The Multi-function button can be defined with two different functions: a long press activates one function, and a double press activates another function.

1. Select **Multi-function button**.
2. Select **Long press**, or **Multi press**.
3. Select **Function**, press **Edit** to select function.
4. Select a function from the list, press **Select** and then press **Back**.
5. Select **Value** (only for some of the functions), and press **Edit**.
6. Enter a value (for example a telephone number) and press **Save**.
7. Select **Control question**, and press **Edit**.

**Note:** By default, the value is **Off**.

## 7 Incoming Calls

The flashing LED, accompanied by a ring signal and/or a vibrating handset, indicates an incoming call. The ring type can tell if the call is an internal, external or callback call. Both ring signal and vibrator can be disabled. The calling party's number, name, or both, is displayed. The name of the caller will be shown if the calling party's phone number is stored in the local or central phonebook.

When a headset is connected to the handset, the answering button on the headset can be used to answer the call.

Other answering methods can also be set. This is done in the **Settings**  menu, see Section 18 on page 83. The answering methods are:

- Automatically
- Loudspeaking

When **Automatically** is enabled, an incoming call will be answered automatically after about one second. The answer behavior is enabled and disabled in the **Settings** menu.

The 25 last received phone numbers are stored in the **Call list**, together with the latest dialled and missed phone numbers, see Section 8.3 on page 42.

### 7.1 Answering Calls

To answer a call, press .

**Note:** Calls can be answered at any time, even during programming, or keying in a number, and so on. When the phone is in idle mode, you can change the answering method.

#### 7.1.1 Mute ring signal temporarily

If the phone rings at an inconvenient moment:



1. Press  to suppress the ringing.

All alert signals will silence for this specific call.

2. Press  to answer the call.

### 7.1.2 Switch ring signal on/off

You can set your phone to Silent Ringing, when your phone is in idle mode:

Press  to switch the ringer on or off. When switched off, the  is shown. All alert signals will silence until the ring signal is switched on again. If the vibrator is set to On when silent, it will alert you of new calls, messages and alarms.

### 7.1.3 Reject a call

If you do not want to take the call, when the phone rings:

Press  to reject the call.

The call is disconnected.

### 7.1.4 Loudspeaking

An incoming call can be connected with loudspeaking function active by pressing the left Soft key. During a call, a press on the left Soft key activates the loudspeaking function. Press the left Soft key again to turn it off.

### 7.1.5 Call diversion

All calls (internal calls, external calls, calls when busy, or calls at no answer) can be diverted to another telephone number. The diversion is made through **Calls - Call services - Divert calls**.

### 7.1.6 End the call

To end a call:

Press .

The display shows the duration of the call.

### 7.1.7 On another extension

To answer a call to a phone in another room:

1. Call the ringing extension and press .

You will hear a busy tone.

2. Press **8**.

**Note:** France press **4**; Sweden press **6**.



## 8 Outgoing Calls

If you make a call but the person is not available, the following functions will help you to establish contact with the called party.

You can also make a call through the Phonebook.

### 8.1 Make Calls

To make internal and external calls:

1. Enter the desired number.

The number is displayed.

2. Press  when the number is correct.

Your phone will go off hook and dial the number. The name of the called party is displayed if connecting line information is available.

**Note:** Correct a wrong entry by pressing the **Clear** key.

If you decide not to make the call while keying in the number, press the **Cancel** key to stop. If you receive a call while keying in the number, simply press the **Yes** key to answer.

You can make your calls faster by using abbreviated numbers or dial-by-name. See Section 13 on page 65

#### 8.1.1 Handsfree

While you are waiting for a connection, dial tone or during the call:

1. Press **Handsfree left soft key**.
2. You are connected to the caller through the loudspeaker and microphone,  is shown in the display.

#### 8.1.2 End the Call

To end a call:

Press .

The display shows the duration of the call.

## 8.2 Last External Number Re-dial

When you initiate an external call, the system automatically stores the number dialled, whether the call was successful or unsuccessful.

To re-dial the last external number dialled:

Press \*\*\* and .



**Note:** Finland and Sweden, dial \*\*0 .

## 8.3 Dialling a Number from the Call List

The 25 last received, dialled and missed phone numbers are stored in the **Call list**. If Clock and Date function is set, it is possible to see the time for the calls made or received that day.

The following day, the time stamp is changed to a date stamp. For more information on time and date settings, see Section 18.3 on page 86.

To dial a number stored in the **Call list**, do the following:

1. Press .
2. Step in the **Call list** and select the number to dial.
3. Press  or **Call**.

The number can be edited before the call is started, to do this, do the following:

- Press **More**.
- Change the number and press  or **Call**.

## 8.4 Automatic Callback

You call an extension and receive busy tone or get no answer. This can also be used if no external line is free:

1. Press **5**.

Verification tone.

**Note:** The number for automatic callback may differ from country to country.

2. Press .

You are called back if the extension finishes the ongoing call or the next time the extension finishes a new call. You have to answer within eight seconds; otherwise the Callback service is cancelled.

**Note:** This function is also accessible using the off hook menu **Call back**.

## 8.5 Busy Extension

You call an extension and receive busy tone.

### 8.5.1 Camp-on

You can notify a busy extension of your call by a muted ringing call (if this function is allowed).

Press **4** to camp-on.

Stay off hook. When the called extension replaces the handset, it will be called automatically.

**Note:** If you receive the busy tone again, the desired extension does not allow Camp-on. The number for busy extension may differ from country to country. This function is also accessible using the off hook menu **Call waiting**.

### 8.5.2 Intrusion

You can intrude on an ongoing call on a busy extension (if this function is allowed).

Press **8** to intrude.

Intrusion tone is heard and a three-party call is established. When the called extension replaces the handset and you keep off hook, the called extension will be recalled automatically.

**Note:** If you still hear the busy tone, then your extension does not have the authority to intrude or the desired extension is protected against intrusion.

The number for intrusion may differ from country to country.

## 8.6 Call Statistics

Your phone can tell you the duration of your last call and display the total time of all calls.

### To see the time spent on your last call and on all outgoing calls

1. Press **Menu** and select .

The following options are available:

- Call list
- Missed calls
- Call time
- Call services

2. Select **Call time** and confirm with **Select**.

The length of the last call but also the duration of all calls is displayed in hours, minutes and seconds.

## 9 During Calls

The BusinessPhone Communication Platform allows you to handle calls in many different ways. You can make an inquiry, transfer the call or create a conference, mute the microphone and ringer, change the dial mode or put the call on hold to perform other tasks.

### 9.1 Inquiry

An inquiry is made when having an ongoing conversation and wanting to make an inquiry to an internal or external party. To make an inquiry, do the following:

1. Press **R** to put the current call on hold.

You hear the dial tone and R is displayed.

2. Enter the number of the third party.

When the third party answers, you can switch between the calls, create a conference and end one of the calls.

#### 9.1.1 Refer Back

You can switch between the connected parties.

1. Press **More** and select **Switch**.
2. Press **1** to terminate.

The ongoing call is terminated. The other call is connected.

**Note:** This function is also accessible using the off hook menu **3rd party**.

### 9.2 Dialling during a call

When calling interactive teleservices, for example telephone banks, you need to use Dual Tone Multi Frequency (DTMF) signals. If the phone exchange is not already programmed to automatically convert entered digits into DTMF signals, this function needs to be activated during the call.

To dial digits during a connected call, do the following:

1. Press **More**.
2. Select DTMF and then enter the required digit keys from 0 to 9.

**Note:** In Finland, press **1** and dial the required digits.

## 9.3 Transfer

To transfer an ongoing call to another extension, do the following:

1. Press **R** to put the current call on hold.

You hear the dial tone and R is displayed.

2. Enter the number of the third party.

When the third party answers, you can switch between the calls, create a conference and end one of the calls.

**Note:** Make sure that you are connected to the desired party. Please read the notes and warnings in Section 19 on page 91.

3. Press  to transfer the call.

Or

Press **R** to return to the first call.

**Note:** This function is also accessible using the off hook menu **3rd party**.

### Transfer to a busy extension

You can even transfer calls to busy extensions. The other party will hear a muted signal (call waiting tone), and the call will be extended as soon as the ongoing call is terminated (if Camp-on is allowed).

### Callback

You are called back if you have transferred an external call and the other extension has not answered the call within a certain time. Your phone will ring again.

## 9.4 Conference

When having an ongoing conversation and want to establish a telephone conference, do the following:

1. Press **More**, mark **New call** and press **Select**.

2. Dial the number and press  .

When the third party has answered, continue with the following to establish a conference.

3. Press **More**, mark **Conference** and press **Select**.

**Note:** You can also press **3**.

- Repeat the procedure to add more conference members.

**Note:** A tone burst is heard each time a participant enters or leaves the conference. When the conference leader leaves the conference, the conference will continue with the other included parties. The conversation is changed back to a normal two party connection when there is only two parties left.

## 9.5 Loudspeaking (Handsfree)

You can switch to handsfree speaking (and back to standard speaking procedure) at any time during a call.

Press  to switch handsfree speaking on or off. During handsfree speaking, you are connected to the caller through the loudspeaker and microphone.

## 9.6 Mute Microphone

To mute the microphone during an ongoing conversation, do the following:

- Press **More** during the call.
- Select **Microphone off** and press **Select**.

The  icon indicates a silenced microphone: the other part in an ongoing call cannot hear you.

To turn the microphone back on, press **More** during the call, and select "**Microphone on** and then **Select**. It also possible to turn the microphone off/on by a long press on .

## 9.7 Call Waiting

If you hear the Call Waiting tone during an ongoing conversation, another person is trying to contact you. To terminate the ongoing call and answer the waiting call:

- Press  to finish the ongoing call.

The waiting call is signalled on your phone.

- Press  to answer the new call.

**Note:** The **Call Waiting** function might be blocked for use on your extension (programmed by your system administrator).

## 9.8 Send a Message

You can send a callback or a voice message when you call an extension and receive busy tone or get no answer.

### Callback message

To send a Call me message:

Press **9#** to send.

### Voice message

To send a voice message.

1. Press **9 9** and speak.
2. Press **\*** to play-back and listen to your recording.
3. Press **9** to register again.
4. Press **#** to send.
5. Press  to finish the procedure.

## 10 Call Forwarding

When you are not available to take calls or decide to answer your calls on another extension, it is useful to forward your calls to an alternate answering position. The alternate answering position can either be a pre-programmed one (one for: Diversion when your cordless is switched off or out of coverage and a common one for: Fixed Diversion, Diversion when there is no answer, Diversion when your extension is busy and Diversion when charging) or an individual one.

If you urgently need to talk to someone who has forwarded his calls, the system is also equipped with a bypass function.

Depending on the type of diversion, you are also able to record your Personal Greeting for your mailbox, see Section 12.5 on page 59.

### 10.1 Diversion when there is No Answer

If you are not available to answer incoming calls (internal or external), your system administrator can program your extension to automatically divert calls to a pre-programmed diversion address after a certain amount of time (default time: 15 seconds).

### 10.2 Diversion when your Extension is Busy

If your extension is busy and you receive an incoming call (internal or external), your system administrator can program your extension to automatically divert the call to a pre-programmed diversion address.

### 10.3 Diversion when your Cordless is Switched off or out of Coverage

If your extension is switched off or out of coverage, your system administrator can program it to automatically divert calls to a pre-programmed diversion address.

### 10.4 Fixed Diversion

This function directs your calls to a pre-programmed diversion address (for example mailbox system or secretary), which is defined by your system administrator.

#### **Activate Fixed Diversion**

1. Press **\*2 1#**  to activate the diversion.
2. Wait for the verification tone.

You can make outgoing calls as usual. A special dial tone and the display info reminds you that a Call Forwarding is active.

### Cancel Diversion

1. Press **#2 1#**  to cancel diversion.
2. Wait for the verification tone.

New incoming calls will be signalled on your phone again.

## 10.5 Diversion when Charging

When the cordless phone is placed in the charger, incoming calls will be diverted to a pre-programmed diversion address (same address as used for the feature Fixed Diversion).

### Activate

1. Press **Menu** and select .
2. Select **In charger** .

The following options are available:

- No action
  - Switch off
  - Redirect
3. Select **Redirect** and then **Back**.

**Note:** If the cordless phone is logged on as secondary phone in a Tandem configuration and placed in the charger, incoming calls will further on be presented on the primary phone and not be diverted.

### Deactivate

Use the same procedure as for activating the feature with the difference that you select the option **Off** instead of **Redirect**.

## 10.6 Individual Diversion

This feature allows you to direct your calls to internal and external addresses, for example to any directory number, a colleague's extension, an external number or a common abbreviated number (for example your mobile phone).

**Note:** This feature can be used through the menu functions of the cordless phone or through the function codes of the Business Phone system. If you fail by using the menu functions, please contact your system administrator.

### 10.6.1

### 10.6.2 Set the Diversion Address Manually

All calls to your extension are diverted to an internal or external answering position of your choice. Either select this position from a list of predefined answering positions, or set the answering position manually. The list of predefined answering positions can be modified. All calls, that is, calls when busy or calls at no answer, can be diverted to other phone numbers.

**Note:** This feature is programmed by your system administrator.

To divert calls to another extension, do the following:

1. Press **Menu** and select **Calls**.
2. Step to the **Call services** menu with the navigation key and press the confirmation button, or **Select**.
3. Select **Divert calls**.
  - a Select **Internal**.OR
  - b Select **External**.

A list with predefined extension names and numbers will appear if the cordless telephone is pre-programmed via the Central Portable Device Manager.

4. Select **Activate** and enter the number to dial, or navigate to the right number in the list.
5. Press **OK**.

### 10.6.3 Cancel Diversion



To stop diversion, do the following:

1. Select **Deactivate**.

2. Press the confirmation button or **OK**.

#### 10.6.4 Add new Predefined Answering Position

To add a new answering position to the call list, do the following:

1. Press **Menu** and select **Calls**.
2. Navigate to **Call services** and select **Divert calls**.
3. Press **Add**.
  - If needed, select **Internal** or **External** and press .
4. Press  and enter the number to the answering position. You can dial the number, or use the Phonebook or the Call list.
5. Press  to confirm.

#### 10.6.5 Delete a Predefined Answering Position

1. Press **Menu** and select **Calls**.
2. Navigate to **Call services**, select **Divert calls**, and then **Delete**. A list of predefined answering positions is displayed.
3. Select the desired position and press **Delete**.
4. Confirm the deletion by pressing **Yes**.

### 10.7 Bypass Call Forwarding

Bypass Call Forwarding makes it possible to call a specific extension, even if Call Forwarding is activated on this extension.

1. Press **\*6 0\***
2. Enter the extension number.
3. Press **#**  and wait for answer

You will be connected to the specified extension, regardless of which type of Call Forwarding the called extension has activated.

# 11 Absence Information

If you are not in the office for a certain period of time (for example meeting, vacation, lunch, illness), this feature allows you to inform your callers why you are absent. External callers will be routed to the operator who also has access to your absence info.

**Note:** When you have activated a diversion with a Personal Greeting, callers will receive this greeting instead of your activated absence information.

You can inform your callers with:

- **Pre-defined texts**  
Enter the reason for your absence and the date and time of your return.
- **Voice information**  
Record a voice message and name the reason of your absence.

## 11.1 Enter Information

### Pre-defined texts

1. Press **Menu**.
2. Select **Calls**.
3. Select **Call services**.
4. Select the menu item **Absence**.

The following options are available:

- Deactivate
- Lunch
- Meeting
- Trip
- Vacation
- Out
- Absent
- Illness

5. Select the reason for your absence
6. Enter the time or time/date of your return.
7. Wait for the verification tone.
8. Press  to finish the procedure.

Information active.

**Note:** Use the navigation keys to switch between A.M and P.M.

#### Completing info

Lunch	back at, hour (00-23) minute (00-59)
Meeting	back at, hour minute
Trip	back on, day (01-31) month (01-12)
Vacation	back on, day month
Absent	back at, hour minute
Illness	back on, day month

Internal callers receive the information on the display (or as spoken information to callers without display phone). External callers will be routed to the operator who also has access to your absence info.

#### Cancel

1. Press **Menu**.
2. Select **Settings**.
3. Select the **Call services** tab.
4. Select the menu item **Absence**.
5. Select the menu item **Deactivate**.
6. Wait for the verification tone.
7. Press  to finish the procedure.

#### Voice information



1. Press \*2 3\* .
2. Press **9** and speak.
3. Press \* to play-back and listen to your recording.

4. Press **9** and speak to re-record.
5. Press **#** to activate.

Internal callers will hear the information through the handset or the loudspeaker. External callers will be routed to the operator who also has access to your absence info.

**Note:** You can dial your own extension number if you want to check your information.

## 11.2 Erase Information, Save Information

1. Press **#2 3#**  to erase information.
2. Wait for the verification tone.
3. Press  to finish the procedure.

**OR**

Press **\*2 3\*#** to deactivate and save for later use.

Information is passive

4. Wait for the verification tone.

### **Use saved information**

When the information is switched off:

1. Press **\*2 3\*#** to activate saved info.
2. Wait for the verification tone.



## 12 Mailbox System

While you are away from the office, callers can leave messages in your mailbox. You are also able to record your personal greeting, see Section 12.5 on page 59. The first time you enter the mailbox system (only possible from own extension), you might be requested to change your password if it is default (0000). See Section 12.8 on page 61 or follow the voice announcements.

**Note:** To use the mailbox system, your extension has to be authorized by the system administrator.

### 12.1 Activate the Mailbox

1. Press \*2 1\*
2. Enter the number of the mailbox system.

Ask the system administrator for your defined mailbox system number.

3. Press # .
4. Wait for the verification tone.

**Note:** For daily use, it is recommended to ask your system administrator to define the mailbox system as your pre-programmed diversion address. Once this is defined, you only have to dial \*21# to activate your mailbox.

The system administrator can also define whether or not the mailbox should be activated if you do not answer your phone after a certain time or if your extension is busy.

### 12.2 Deactivate the Mailbox

1. Press #2 1# .
2. Wait for the verification tone.

**Note:** The mailbox is still active if is defined as pre-programmed diversion address for the feature Diversion when there is no answer and Diversion when your extension is busy.

### 12.3 Access the Mailbox

The following mailbox functions can be accessed from your own extension, any other internal extension or from an external position (for example mobile phone).

- Listen to available messages
- Change your personal greeting
- Send messages
- Set up Outcall (External)
- Notification (configuration dependent)
- Change your password

#### Access the mailbox from your own extension

Press \*5 9# 

Listen and follow the voice announcements in the main menu.

**Note:** Depending on the configuration, you might be asked for your password before you can enter your mailbox.

#### Access the mailbox from any other extension

Dial the directory number of the mailbox system.

Listen and follow the voice announcements in the main menu.

#### Access the mailbox from an external position (for example mobile phone)

Dial the public number of your company.

Dial the directory number of the mailbox system. Listen and follow the voice announcements in the main menu.

## 12.4 Listen to your Messages

Received messages are divided into the following three categories:

- New messages (not heard)
- Heard messages
- Stored messages.

**Note:** Messages are deleted from the system after a certain time. Please contact your system administrator.

1. Access the mailbox.

(See Section 12.3 on page 57)

Listen and follow the voice announcements in the main menu.

2. Select **1** to listen to available messages.

**Note:** If there are no messages in your mailbox, the option to listen to your messages will not be available.

3. Select one of the three message categories (new, heard, stored).

Listen to your messages and follow the voice announcements in the dedicated menu.

- play message again
- forward a message
- get date and time info
- pause during play
- play previous message
- store message
- play next message
- erase message

**Note:** Voice messages will be heard. **Call me** messages will call the sender (these messages cannot be stored).

4. Press  to finish the procedure.

### Forward a Voice Message

A copy of your received voice messages (in the individual mailbox) can be forwarded to other mailbox numbers (individual or common). When you forward a voice message (heard or stored) to an individual mailbox, the mailbox number is the same as the extension number.

**Note:** The forwarded message is a copy, that is to say it can be deleted without deleting the original message.

There are no distribution list numbers available. Forwarding the same message to more than one mailbox must be done in single operations.

## 12.5 Change your Personal Greeting

Depending on the type of call diversion to the mailbox, you can leave three different personal greetings for the caller. You can activate a diversion when a caller receives busy tone, when there is no answer, or you can activate a fixed or individual diversion for all your calls.

1. Access the mailbox.

(See Section 12.3 on page 57) Listen and follow the voice announcements in the main menu.

2. Select **2** to change your **Personal Greeting**.
3. Select the desired diversion type.

Listen and follow the dedicated voice announcements. When you activate the diversion, the recorded greeting is played to the next caller.

4. Press  to finish the procedure.

**Note:** When you have activated a diversion with a Personal Greeting, callers will receive this greeting instead of your activated absence information.

## 12.6 Send Messages through your Mailbox

With this function, the mailbox system allows you to record and send messages from your mailbox to any other internal mailbox without calling the respective mailbox owner. A recorded message can either be sent to one or to multiple mailboxes.

**Note:** There are no distribution list numbers available. Sending the same message to more than one mailbox must be done in single operations.

1. Access the mailbox.

(See Section 12.3 on page 57) Listen and follow the voice announcements in the main menu.

2. Select **3** to record and send messages.

Listen and follow the dedicated voice announcements.

Messages can be heard or re-recorded before they are sent to a mailbox.

**Note:** A message can also be sent during a call, see Section 9.8 on page 48.

3. Press  to finish the procedure.

## 12.7 Outcall (External) Notification

With this function, the message system can notify you when new voice messages arrive. You can specify an external number where you will be called at a pre-programmed time or as soon as a new message arrives.

**Note:** This feature may be restricted or not available. Ask the system administrator for the availability and more information.

You can be notified in two different ways (depending on the programming of the system):

- Notification with mailbox access: you acknowledge the notification through your password (has to differ from the default value 0000). See Section 12.8 on page 61 to select a new password. You have full access to the mailbox system.
- Notification without mailbox access: you get a short voice announcement informing you that someone has left a message for you. You acknowledge the notification by pressing any key. You have to call back the mailbox system to retrieve the message.

**Note:** If you do not acknowledge the notification within the pre-programmed time, the connection is cancelled and repeated later (ask the system administrator for the programmed number of notification attempts).

1. Access the mailbox. (See Section 12.3 on page 57) Listen and follow the voice announcements in the main menu.
2. Select **4** to set up outcall notification.

Listen and follow the dedicated voice announcements.

You can program the external notification number, the notification time and activate/deactivate the function. The external number (including the digit(s) for external line access) can consist of up to 24 digits. The time is entered in 24h-format, for example. 2030 for half past eight with values automatically set to even quarters, that is to say 2013 will be 2015.

**Note:** The notification number and time must be programmed before you activate the notification.

3. Press  to finish the procedure.

## 12.8

### Change Password

#### Change the password through your mailbox

1. Access the mailbox.  
(See Section 12.3 on page 57)
2. Select **5** to change the password.

Listen and follow the dedicated voice announcements.

3. Press  to finish the procedure.

**Note:** The password can also be changed without accessing the mailbox by using the procedure Section 12.8 on page 61.

### Change the password through the telephone

1. Press **#\*7 2\*** to select a new password.
2. Enter your present password.  
The default password is 0000.
3. Press **\***
4. Enter your new password.
5. Press **#** and wait for the verification tone.

6. Press  to finish the procedure.

## 12.9 Dictaphone Function

If you want to record and retrieve personal voice messages (memos), you can use the Dictaphone function. A dictaphone message is treated as a normal message. For information on how to retrieve dictaphone messages, see Section 12.4 on page 58.

### Record message

To start recording:

1. Press **\*5 8#** .
2. Wait for the verification tone. "RECORDING" is displayed.
3. Record your message.

The maximum recording time is four minutes and 15 seconds. Select one of the options below:

4. Press **\*** to play back.  
Or  
Press **9** and speak to re-record.  
Or

Press  to stop the recording and save the message.

## 12.10 Text Messages (optional)

You can send and receive messages, also known as SMS (Short Message Service), to and from other phones in your system.

**Note:** Text messages can only be received and sent if the Aastra Integrated Messaging Server is installed in your system. Please contact your system administrator.

### Receive text messages (SMS)

When a text message is received, the LED starts flashing and a message tone sounds.

If the message is received during a call, a beep notifies the user.

The message is stored in the message list. The “New message” icon is shown in the display. The icon will remain in the display until all new messages are opened.

1. Press **Menu**.
2. Select **Messaging**.

The following options are available:

- Inbox
- Write new message
- Unsent
- Sent

3. Select the menu item **Inbox**.

The message list is displayed.

4. Scroll to find the message. The selected message is highlighted.
5. Press to read the message.

The message text is displayed followed by **Proceed?**.

6. Press **Clear** to delete the message.

Or

Press  to proceed to the next menu.

This menu gives you additional options, such as Remove or Forward the message, to call (Numbers in the text) or to read next message.

### **Send text messages (SMS)**

1. Press **Menu**.
2. Select the **Messaging** tab.

The following options are available:

- Inbox
- Write new message
- Unsent
- Sent

3. Select the menu item **Write new message**.

The following options are available:

- Unsent
- New
- Outbox

4. Enter your message and confirm with **Send**.

For information on how to write text, see Section 5.6 on page 33.

5. Enter the phone number.
6. Press **Send** to send the message.

## 13 Abbreviated numbers

By using abbreviated numbers, you can make calls simply by pressing a few keys. Frequently used external numbers are stored as common abbreviated numbers in the exchange. Up to 10 individual abbreviated numbers (your personal most frequently used external numbers) can be stored and used on the digit keys 0 to 9.

### 13.1 Common Abbreviated Numbers

External numbers are stored centrally in your BusinessPhone Communication Platform. Common abbreviated numbers can be dialled from every extension that has the authority to do so.

1. Enter the common abbreviated number.

Please refer to your telephone directory.

2. Press  to make the call.

### 13.2 Individual Abbreviated Numbers

You can program and activate your most frequently used external numbers on the digit keys 0 to 9.

1. Press \*\*
2. Enter the abbreviated number.

A number between 0 and 9.

3. Press  to make the call.

#### **Program individual abbreviated number**

How to program external numbers on the digit keys 0 to 9.

1. Press \*5 1\* to enter programming mode.
2. Enter an abbreviated number between 0 and 9 and press \*
3. Enter the digit(s) for external line access and the external number.

The number can consist of up to 24 digits.

**Note:** Your public network requires waiting for a second dial tone, press \*

4. Press # 
5. Wait for the verification tone.

**Cancel one specific individual abbreviated number**

1. Press **#5 1\***
2. Enter an abbreviated number between 0 and 9 and press # .

3. Press 
4. Wait for the verification tone.

## 14 Group Features

When you are working together in a team, the following group features can be very useful.

### 14.1 Group Hunting

Your phone can be included in one or several hunt groups. In a hunt group, all members are represented with one common directory number. 16 hunt groups can be programmed, each containing 1 to 20 members. A member can be either an extension number, an operator console or a fictive number. Please ask your system administrator if you require this function.

**Note:** The number of cordless extensions in a hunt group is limited to eight (including tandem configurations).

Incoming calls to the hunt group are directed to free extensions in the group. The hunt order within the group can be changed to suit your needs. If all members of the hunt group are busy, an incoming call is being queued. If no one answers this call before the programmed time, the call is forwarded to the programmed diversion address (for example operator).

**Note:** If all members in a hunt group are busy, the Callback or Intrusion functions are not available.

#### 14.1.1 Log in

Before you can answer group hunting calls, you must log in.

##### To log in to one hunt group

1. Press **\*2 8\***
2. Enter the hunt group code.

Please ask your system administrator for the configured number.

3. Press # .
4. Wait for the verification tone.

##### To log in to all hunt groups

1. Press **\*2 8\*\*\*#**
2. Press .

3. Wait for the verification tone

### Answer calls

It is possible to have group hunting information in the display. If you require a different display layout, please contact your system administrator.

Answer group hunting calls in the normal way.

## 14.1.2 Log out

### To log out from one hunt group:

1. Press **#2 8\***
2. Enter the hunt group code.

Please ask your system administrator for the configured number.

3. Press # 
4. Wait for the verification tone.

**Note:** If you are logged in to more than one hunt group and log out from one of them, the display will show the following text: PBX Group(s) logged out.

### To log out from all hunt groups:

1. Press **#2 8\*\*#**
2. Enter the hunt group code.

Please ask your system administrator for the configured number.

3. Press # 
4. Wait for the verification tone.

## 14.2 Group Call-pick-up

In a Pick-up group, any member can answer any individual call to group members. You answer a call to the group by dialling a special answering number.

Please ask your system administrator for the configured number.

Enter the group call pick-up code and press  .

## 14.3 Common Bell Group

The Common Bell feature allows all extensions of the system (operator included) to pick-up the call from an extension that has been predefined as a common bell extension:

Enter the Common Bell pick-up code and press



Please ask your system administrator for the Common Bell pick-up code. If two or more extensions simultaneously attempt to answer a call from the Common Bell extension, only the first extension will pick it up. The other extensions will receive the *number unobtainable tone*. This will also happen if you dial the Common Bell pick-up code and there are no calls waiting at the Common Bell extension.



## 15 Other Useful Features

By using these features, your productivity will be increased, for example you can set reminders for important meetings, or place the costs for external calls on separate accounts.

### 15.1 Automated Attendant

The Automated Attendant feature sends voice instructions to external and internal callers, informing them of all possible options they can choose. Voice instructions lead the callers step by step to the desired destination.

1. Enter the Automated Attendant directory number.

Please ask your system administrator for the automated attendant directory number.

2. Press  and follow the voice instructions.

### 15.2 Doorphone

The Doorphone is used to monitor the admission to your company, that is to say you can open the doorlock from your phone.

#### Answering doorphone calls

Press . You will be in speech connection with the calling party.

#### Opening of the doorlock

After you have answered the doorphone, you can open the door by making an inquiry to the door-opener's directory number.

1. Press **R**.
2. Enter the door-opener's directory number.

Please ask your system administrator for the number.

### 15.3 Account Number

An account number can be entered to debit telephone costs to different accounts. Depending on the system configuration, the account number has to be entered from a verified account number list (predefined) or you can invent your own account number. The following pre-requisites apply:

- With the Verified Account Number you can restrict the making of external calls (not a specific number or area), so everyone who is allowed to make external calls will receive an account number which has to be used each time he/she wants to make an external call.
- Verified account numbers contain up to 10 digits.
- Own account numbers contain up to 15 digits.

The account numbers can also be used through the DISA function, see Section 15.4 on page 72.

### Verified or own account number

Before an outgoing call:

1. Press\* **9** \*

2. Enter account number and press #.  .

Valid digits 0-9. Internal dial tone. Make the external call.

## 15.4 Direct Inward System Access (DISA)

If you are working externally and you have the need to make business calls, call your company and use the company PBX to make an external call to the desired party. You just pay the costs for the phone call to your company. The other costs will automatically be placed on your extension number or on a special project.

**Note:** To use the DISA function, your extension has to be authorized by the system administrator. To activate the DISA function, you have to change the default password from “0000” to a personal one, see Section 12.8 on page 61.

You can also divert calls from your office extension to your external position, see Section 10 on page 49. During the procedure you will be prompted for your password.

1. Enter the public number of your company, followed by the DISA number.

Ask the system administrator for the defined DISA number.

**Note:** If want to register the call on an account number, you should use the Account Number procedure before you enter the external number, see Section 15.3 on page 71.

2. Follow the voice announcements.
3. Dial the digit(s) for external line access and the desired public number.

**Note:** Which digit to press for external line access depends on the configuration of the system.

Or:

Use the External Diversion function. Procedure, see Section 10 on page 49.



**Note:** If you program a new diversion address, remember to reset it when you return to your office.

## 15.5 Tandem Configuration

The tandem configuration is a unit, consisting of two phones using the same directory number. One of the phones is defined as the primary and the other one as the *secondary*.

This function enhances the communication for users that, for example, have a wired phone on their desk (the primary phone) and need to be mobile within their company's building with their own Cordless phone (the secondary phone). Basically, the tandem configuration works as follows:

### To activate the Tandem Configuration

1. Press **\*2 8#**  to log on the secondary phone.
2. Wait for the verification tone.
3. Press  to finish the procedure.



For incoming calls:

- Both phones are treated as **1 single extension**.

For outgoing calls:

- Both phones are treated as **2 separate extensions**.

### To deactivate the Tandem Configuration

1. Press **#2 8#**  to log off the secondary phone.
2. Wait for the verification tone.
3. Press  to finish the procedure.

For incoming calls:

- The secondary phone cannot be called and the primary phone works as a normal stand-alone phone.

For outgoing calls:

- Both phones are treated as **2 separate extensions**.

### Transferring a call between members of a Tandem Configuration

1. Press **R** and enter own directory number.

2. Press  to transfer the call.

## 15.6 Networking

Networking is the connection of several premises within a company. The connection can be set up through leased lines, public lines, Local Area Network (LAN) or Wide Area Network (WAN). Ask your system administrator about details regarding networking.

## 15.7 IP calls

IP calls are internal calls sent through an internal data network (LAN or WAN) and the transfer of data and voice is made on the same line. If you are connected to an internal data network, the IP connection is made automatically. To minimize the traffic on the network, the speech quality is decreased.

If the speech quality is not acceptable, you can disconnect the IP call and switch to a non-IP call (Alternative network). The switch from the IP net to the non-IP net is made during the call, so the call does not have to be disconnected.

### If you want to switch to a non-IP net during the call:

1. Press **R**
2. Press **\*6 1\***

During the procedure the other party is put on hold. When the procedure is ready, you will receive a special ringing tone and the call is resumed in the non-IP net.

**Note:** A switch to a non-IP call can only be performed if the original call is an IP call, otherwise you will receive a blocking tone.

## 15.8 Key lock

To prevent accidentally pressing keys, you can have them locked by using the Automatic Key lock option.

**To lock the keypad**

Press  and then the **Lock** softkey.

**To unlock the keypad**

Press  and then the **Yes** softkey.

**Note:**

It is possible to call an emergency call and to answer/close an incoming call while the keypad is locked.



# 16 Security

## 16.1 Phone Lock

You can protect your phone against unauthorized use or against adding or deleting telephone network subscriptions. Both security features are off by default.

### Securing against unauthorized use

You can set the phone so that the PIN code must be entered after switching on.

1. Press **Menu**.
2. Select .
3. Select **Locks**.

The following options are available:

- Automatic key lock Off
- Phone lock

4. Select **Phone lock**.

The following options are available:

- Auto phone lock Off
- Change PIN code

5. Select **On**.
6. When using the phone for the first time, enter the New code(2) and confirm.
7. For changing the code, enter the current code (Old code) and confirm.
8. Enter the digits of the new code (New Code(1)).
9. Enter the new code (New Code(2)) again and confirm.

Either the new code is accepted or **Wrong Code!** is displayed. If **Wrong Code!** is displayed, you have entered a number that does not match the current code. When the new code is accepted, the phone lock is enabled.

Note the new code for future use.

## 16.2 Block Extension

You can block your extension in order to prevent unauthorized external calls. You can still make internal calls and you can also receive incoming calls.

1. Press **#72\***  to block your extension.
2. Wait for the verification tone.

### Unblock Extension

1. Press **#7 2\***
2. Enter your password.

**Note:** To change your password see Section 12.8 on page 61.

3. Press **#**, then  to reopen.
4. Wait for the verification tone.

Your extension is open for use.

## 16.3 Bypass Blocked Extension

In order to make a call, you can temporarily bypass a blocked extension by using your personal password.

**Note:** To change your password see Section 12.8 on page 61.

### Bypass own extension

1. Press **\*7 2\***
2. Enter your password.

3. Press **#**  .

Dial tone. You can make one call from your extension.

### Bypass another extension

This makes it possible to make a call on another, blocked extension, by using your password.

1. Press **\*7 2\***
2. Enter your password.

3. Press \*
4. Enter your extension number.
5. Press # 

Dial tone. You can make one call from the blocked extension. However, it will be registered as a call which is done from your own extension.



# 17 Least Cost Routing

This section describes how to use the Least Cost Routing.

## 17.1 Use Least Cost Routing

Enter the digit(s) for external line access and the desired public number.

The usual way of making an outgoing external call.

**Note:** Which digit to press for external line access depends on the configuration of the system.

## 17.2 Calling Least Cost Routing

If LCR has been installed in your system, but your extension is not configured to use it automatically, you also have the opportunity to get the cheapest connection by dialling the LCR code before you dial an external number.

1. Enter the LCR code.

Please ask your system administrator for the LCR code.

2. Enter the digit(s) for external line access and the desired public number.

The usual way of making an outgoing external call.

**Note:** Which digit to press for external line access depends on the configuration of the system.



# 18 Settings

The associated number for using the Automatic Callback, Camp-on or the Intrusion function may vary from country to country. If you cannot use a code of a function, maybe your exchange system has been programmed with a different associated number.

## 18.1 Sound & Alerts

### 18.1.1 Volume Control

You can adjust the volume in the ear piece, of the loudspeaker for handsfree speaking and the volume of the ringer. Use the volume keys to adjust the volume, see Section 3 on page 13 for the location of the volume controls.

To turn the microphone, ringing sound and warning sound on or off during a call, see Section 9 on page 45.

#### **Adjust loudspeaker volume for handsfree speaking**

Press ▲ or ▼ buttons to adjust the volume during a call.

#### **Adjust ear piece volume**

Press ▲ or ▼ buttons to adjust the volume during a call. The phone will now store and keep the new volume level.

#### **Adjust ringer volume**

1. Press **Menu**.
2. Select .
3. Select the menu item **Sound & Alerts**.
4. Select **Volume**.
5. Press ◀▶ to turn the volume up or down and confirm with **OK**.



### 18.1.2 Ringer Tones or Melodies

Different signals for internal calls, external calls and callback can be set. By default, there are 14 different signals in the telephone, and 10 additional signals can be downloaded to the handset.

**Note:** Ask your system administrator on how to download additional signals to your phone.

### To set the sound for a ringing type





1. Press  .
2. Select  .
3. Select the menu item **Sound & Alerts** and confirm.
4. Select the menu item **Ring signals** and press **Select** to confirm.
5. Select the ringing signal type: Internal, External, or Callback and press **Select** to confirm.
6. Select the desired sound by pressing **Play**.  
The selected sound is played.
7. Press **Select** to confirm and save the settings.

### 18.1.3 Message Alert

You can select different signals for mail and voice messages. By default, there are 16 different signals in the telephone, and additional signals can be downloaded to the handset.

#### To set the sound for Message Alert



1. Press  .
2. Select  .
3. Select the menu item **Sound & Alerts** and press **Select** to confirm.
4. Select the menu item **Message alert** and press **Select** to confirm.
5. Select the message alert type and confirm with **Select**.

### 18.1.4 Vibrator Alert

If you do not want to be disturbed by the ringing of your phone, but still get the call indication, or if you are in a noisy environment, you can activate the Vibrator alert.



1. Press  .

2. Select .
3. Select the menu item **Sound & Alerts** and press **Select** to confirm.
4. Select the menu item **Vibrating alert** and confirm.



The following options are available:

- **On** for Vibrator alert.
  - **On if silent** for Vibrator alert when the ringer is permanently off. See Section 18.1.1 on page 83.
  - **Off** for no Vibrator alert.
5. Select the desired option and press **Select** to confirm.

### 18.1.5 Key Sound

Key sound is the sound you hear each time you press a key. This feature can be enabled and disabled.



1. Press .
2. Select .
3. Select the menu item **Sound & Alerts** and press **Select** to confirm.
4. Select the menu item **Key sound** and press **Select** to confirm.
5. Select one of the following options:
  - **Click** to have a Key sound with each key press.
  - **Tone** to have a Key sound with each key press.
  - **Silent** for no Key sound.
6. Press **Select** to confirm and save the settings.

## 18.2 Display Brightness

Your phone has a display which is illuminated when a key is pressed. The illumination automatically goes off after a while, unless you press a key.



1. Press .

2. Select 
3. Select **Display**.
4. Select **Brightness**.

The following options are available:

- Normal
- Power save

The current setting is indicated.

5. Select one of the options:
6. Press **Back** to confirm and save the settings.

## 18.3 Time and Date Settings

The time and date information is updated automatically by the system.

### Set time format

1. Select **Time & Date** and press **Select**.
2. Select **Time format**.

The following options are available:

- 24 hour
- 12 hour

3. Press **Select** to save the setting.

### Set date format

1. Select the menu item **Time & Date** and press **Select**.
2. Select **Date format** and press **Select**.

The following options are available:

- DD/MM/YYYY, that is, 17/09/2007 (also called Europe)
- MM/DD/YYYY, that is, 09/17/2007 (also called US)
- YYYY-MM-DD, that is, 2007-09-17 (ISO 8601)
- MMM DD YYYY, that is, Sept 17 2007
- DD MMM YY, that is, 17 Sept 07



- DD.MM.YYYY, that is, 17.09.2007
  - DD-MM-YYYY, that is, 17-09-2007
3. Press **Select** to save the setting.

## 18.4 Changing Answering Methods

The phone can be set to answer a call automatically when a headset is used, or to answer a call by a press on any key.

### 18.4.1 Normal Answering

The answering behavior is by default set to Hook-off. It can be set to any key by doing the following:

1. Enter .
2. Navigate to **Answering**, and select **Answering key**.
3. Select **Any key** or  and press **Back** to save the setting.

### 18.4.2 Automatic answer

**Note:** The automatically answer mode is only relevant when a headset or a Bluetooth headset is connected.

To set the phone to answer automatically, do the following:

1. Enter .
2. Select **Answering** and then select **Answer behaviour**.
3. Select **Automatically** and press **Change** to activate the automatic mode.
4. Press **Back** to save the setting.

All incoming calls will be connected automatically when this behavior is selected.

To remove the setting, press **Change**.

### 18.4.3 Automatic Loudspeaker

To set the phone to automatically answer with loudspeaker, do the following:

1. Enter .

2. Select **Answering** and then **Answering behaviour**.
3. Select **Loudspeaking** and press **Change** to activate the loudspeaking mode.
4. Press **Back** to save the setting.

All incoming calls will be connected in loudspeaking mode when this behavior is selected.

To remove the setting, press **Change**.

## 18.5 Modifying the Size of Messages

To modify the text size of messages:

1. Enter .
2. Select **Messages**.
3. Select **Text size** and press **Select**.



The following options are available: **Normal** or **Large**.

4. Select the size and press **Back** to save the setting.

## 18.6 Language

The default menu language is English. To select another language, use the **Language** option. Please note that the menu options stay in English until you confirm your language choice.



1. Press .
2. Select .
3. Select the menu item **Language**.

All available languages are displayed and the current language is indicated.

The available languages are Brazilian Português (Brazilian Portuguese), (Czech), Dansk (Danish), Deutsch (German), English, Español (Spanish), Français (French), (Greek), (Hungarian), Italiano (Italian), Nederlands (Dutch), Norska (Norwegian), (Polish), (Russian), (Slovakian), Soumi (Finish), Svenska (Swedish), and (Turkish).

4. Select the desired language and press **Select** to confirm.

Wait for the phone to change language and connect to the network again.

**Note:**

- The telephone will need to search the system while switching menu language.
- If, by mistake, you changed the language, the \* before Language will allow you to easily find where in the menu to switch languages.



## 19 Useful Hints

This section gives details about external calls.

### **Connections between external lines**

With your BusinessPhone Communication Platform, you can establish an external call diversion or a conference with more than one external party or transfer an external call to another external destination (for example, a mobile phone). These features are very useful for everyday business life.

**Note:** When these features are used, your BusinessPhone Communication Platform will occupy at least two external lines.

However, there may be disadvantages in connecting to several external lines. We would therefore like to draw your attention to the following:

- **Please do not transfer external calls to an external mailbox, to information systems or to external parties before they have answered.**
- **If you are connected to two external lines, cancel one call by pressing “R” and “1”.**

If the external parties are not persons (mailbox, automated information or attendant systems, etc.), connections on external lines can last a long time, which can be costly. Moreover, such calls may occupy two of your system's external lines. You can restrict connections between the external lines by reprogramming your system.

Please ask your system administrator or contact our service center for more information.



## 20 Installation

This section describes how to charge the battery, configure the headset or use the belt clip.

### 20.1 Check for completeness

Make sure that all the parts are present. If anything is missing, please contact your system administrator or supplier.

The set contains:

1. Cordless phone
2. Battery
3. Clip
4. Assembly card

**Note:** It is important to make a note of the IPEI code. The IPEI code may be needed for unblocking the Cordless phone if an incorrect PIN code has been entered three times. See Section 2.4 on page 10 for further details.

### 20.2 Battery

The battery compartment with the Li-Ion battery is placed on the rear side of the handset.

#### 20.2.1 Charging the Battery

The battery requires charging when the **Battery** icon in the display indicates low level. Place the phone in the charger. The charging status is shown by the **Battery** icon in the display. An empty battery is fully charged after approximately 4 hours, indicated by a filled **Battery** icon.

#### 20.2.2 Spare batteries

Spare batteries can be charged with a separate battery pack charger which charges six batteries in a row.

### 20.2.3 Replacing the Battery

If the standby time for the cordless telephone becomes too low, the battery should be replaced by a new one. Please contact your system administrator or your supplier, for information about new batteries. Attach the battery as described in the illustration below. The battery is attached inside the battery lid and is connected to the cordless telephone in such a way that no miss-contact is possible.

**Note:** To avoid wearing out the phone's battery connector, use the charger instead of repeatedly replacing an empty battery with a new one.

To replace the battery:

1. Unlock the lid and remove the battery.

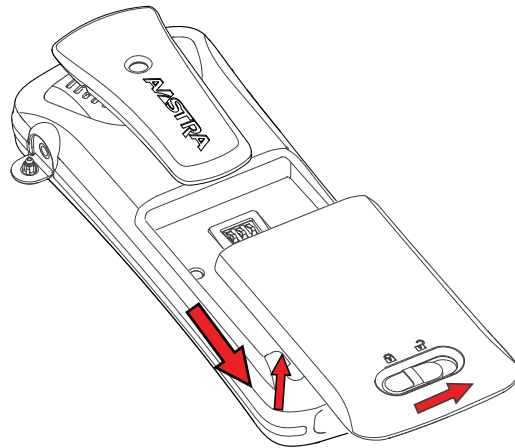

2. Replace with a new battery.

## 20.3 Desktop Charger

There are two desktop chargers available, one basic and one advanced, see Figure 14 on page 95.

<b>Basic</b>	Charging only
<b>Advanced</b>	Charging, software download, and synchronizing of parameters.

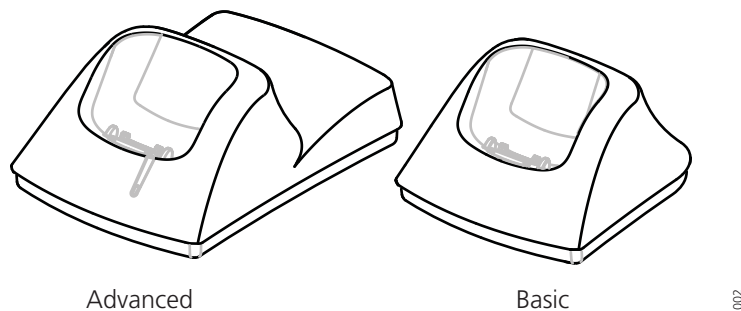

Figure 14 Desktop chargers

The charger is delivered with a plug-in power supply and is connected into an ordinary wall socket.

**Note:** Only use the charger within the temperature range of 5 - 40° C. Only use the provided power supply.

### Advanced charger

To use the advanced desktop charger for software download and synchronizing parameters, the charger must be connected to a PC with Portable Device Manager (PDM) software installed. For a description of PDM, see Section 20.9 on page 97.

The charger is connected to a PC through the USB or one of the network connectors, see Figure 15 on page 95. When connecting the charger with a PC through one of the network connectors the charger acts as a switch, which makes it possible to connect the other connector to the LAN.



Figure 15 Network and USB connectors

**Note:** Network and USB connectors are used to connect the desktop charger to a PC running the PDM (not for charging).

### Power adapters

Article number :

- NTM/BMLNB 101 17/1 (EU)
- NTM/BMLNB 101 17/2 (UK)
- NTM/BMLNB 101 17/3 (AU)
- NTM/BMLNB 101 17/6 (110V)

## 20.4 Rack Charger

The charging Rack is used for charging several telephones, to synchronize parameters, and for software download.

## 20.5 Battery Pack Charger

The battery charger is used for charging up to six spare batteries.

## 20.6 Headset

A headset is recommended if you frequently use the phone, and/or want to have both hands free. The phone has a special headset connector.

## 20.7 Hinge-type Clip

To attach the clip:

1. Attach the hinge-type belt clip.
2. Screw the hinge-type clip into position

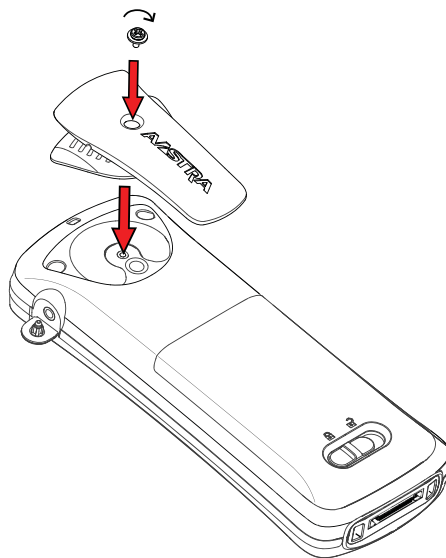

## 20.8 Swivel-type Clip

To attach the clip:

1. Attach the swivel-type belt clip.
2. Screw the swivel-type clip into position.

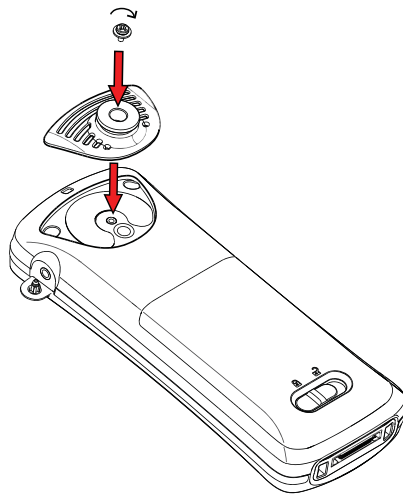

## 20.9 Portable Device Manager

It is possible to upgrade software and synchronize parameters in your DT390 cordless phone with the Portable Device Manager (PDM) software. PDM exists as a Windows version (Desk PDM) and as a System version (CPDM), and is most often used by system administrators only. Desk PDM can be used together with the advanced desktop charger. The advanced desktop charger is connected to the PC with PDM software through the network or USB connectors at the back of the charger, see Figure 16 on page 97.

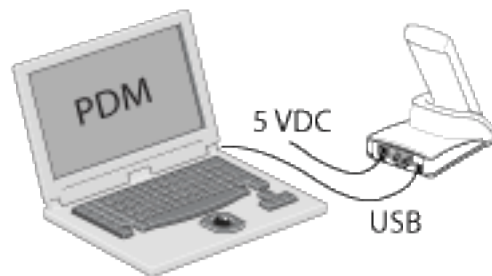

Figure 16

For more information on PDM or upgrading of your cordless phone, contact your system administrator.



## 21 Reference

This section describes the terminology used on the display, the phone communication signals, guidelines, technical specifications, spare parts and accessories.

### 21.1 Terminology

The list below explains the terms which may appear on the display.

<b>Term</b>	<b>Meaning</b>
DTMF	Dual Tone Multi Frequency or touch tone, for dialling.
IPEI	International Portable part Equipment Identity, unique identity assigned to your Cordless phone by the manufacturer.
PIN	Personal Identification Number for security.

### 21.2 Phone Signals

The Cordless phone signals certain events audibly and visually as described below

<b>Signal</b>	<b>Meaning</b>
Red warning light	Incoming call. Message waiting. Battery almost empty. Cordless phone out of range or not connected

The Cordless phone also generates audible ringing signals, alarm signals and warning tones, and key clicks

<b>Sound</b>	<b>Meaning</b>
Ringing signal	Incoming call. 4 short beeps every 30 seconds: battery almost empty. 4 short beeps every 2 minutes: Cordless phone out of range or not connected.
Key click	You hear this each time you press a key (when selected).
Warning tone	You pressed a key which has no function.

## 21.3 Maintenance

Consider these suggestions and guidelines to keep your phone in good shape and working properly.

**Note:** The phone does not contain user serviceable parts. If your phone requires service, you should return it to the supplier or retailer from whom it was bought.

### Intrinsic safety

Do not use the phone and charger in conditions where there is a danger of electrically ignited explosions.

### Battery disposal

Defective batteries must be returned to a collection point for chemical waste disposal.

### Treatment

Do not expose the phone and charger to direct sunlight for long periods. Keep the phone and charger away from excessive heat and moisture.'

### Cleaning

Clean your phone with a soft cloth moistened with water only. The use of soap and other cleaning products can discolor and damage the phone. Clean the battery contacts using ethanol or isopropyl alcohol.

## 21.4 Technical Specifications

### DECT GAP/CAP

The Cordless phone has the unique advantages of DECT GAP/CAP (Digital Enhanced Cordless Telecommunications Generic Access Profile/CTM Access Profile). This means that no one can eavesdrop on your calls and that the quality of speech is as good as that of conventional fixed telephones. DECT GAP/CAP enables interoperability with other manufacturers' products.

### Cordless phone



*Table 1*

<i>Physical</i>	
Dimensions (l × w × d):	134 x 53 x 26 mm
Weight:	130 g (battery and clip included)
Material:	Case: PC-ABS, Key pad: PC, Clip: PPA

Color:	Grey
Display (w x h):	28 x 35 mm, CSTN display
Clip:	Hinge-type (standard) or swivel type
<i>Battery</i>	
Type:	Li-polymer/Li-Ion
Speech time:	20 h
Stand-by time:	240 h <sup>(1)</sup>
Speech time with Bluetooth option:	13 h with Bluetooth headset in use
Stand-by time with Bluetooth option:	120 h <sup>1</sup>
Charge time:	< 4 hours
Discharge/charge cycles:	>=80% capacity left after 400 full charge/discharge cycles
<i>Connectors</i>	
Multi-purpose connector:	For battery charging, software download, and configuration
Headset connector:	Standard 2.5 mm
<i>User interface</i>	
Display (w × h):	Multiple colors with high resolution, more than 65k individual colors. 128 × 160 pixel LCD with white LED backlight
Indicator:	LED on top/front for visual indication of incoming call, message. The LED may also be used for visual indication of normal function.
Vibrator:	Incoming call/message
Keypad:	<ul style="list-style-type: none"> <li>• Soft keys (3)</li> <li>• Hook off</li> <li>• On hook and Power On/Off (Symbol) on the same key</li> <li>• Five way navigation key (“OK” in the centre of key)</li> <li>• Numerical keys</li> <li>• Volume up/down</li> <li>• Multifunction button</li> </ul>
<i>Audio</i>	

Ring signal:	Adjustable in 8 steps
Earpiece:	Adjustable in 8 steps of 3dB each.
Maximum sound Ring signal level:	88 dBA at 10cm
Loudspeaker:	Duplex loud speaking function.
<i>Settings</i>	
Languages:	18 (Danish, Dutch, English, Finnish, French, German, Italian, Norwegian, Portuguese (Brazilian), Spanish, Swedish, Polish, Greek, Czech, Hungarian, Russian, Slovakian and Turkish).
<i>Central Phonebook</i>	
Maximum name and number length:	40 characters in a name and 20 digits in a number
<i>Local Phonebook</i>	
Storage of contacts:	<ul style="list-style-type: none"> <li>• 48 character name</li> <li>• 24 digit work number</li> <li>• 24 digit mobile phone number</li> <li>• 24 digit other number</li> <li>• A selectable ring tone</li> </ul>
<i>Telephony</i>	
Indication:	14 ring signals, flashing LED and vibrator.
Answer call:	Button press or auto answer
Call list storage capacity:	25 received, dialled and missed calls with time stamp
<i>Messaging</i>	
Maximum message length:	160 characters
Storage capacity:	30 received/sent messages (> 20 000 characters)
<i>Radio</i>	
Receiver sensitivity:	-93 dBm
Compliance to DECT GAP standard:	EN 301 406 and TBR 22 test
Automatic DECT protocol detection:	Automatic detection and configuration for US DECT and EU DECT at first registration.

Frequency range:	<ul style="list-style-type: none"> <li>• EU: 1880-1900 MHz</li> <li>• U.S.: 1920-1930 MHz</li> <li>• L.A.: 1910-1930 MHz</li> </ul>
Modulation:	GFSK
Channel spacing:	1.728 MHz
Antenna:	Integral
Sensitivity:	-93 dBm
Radiated power:	EU : +25 dBm EIRP U.S.: +22 dBm EIRP
<i>Environmental</i>	
Operating temperature:	0°C to +40°C
Storage temperature <sup>(2)</sup> :	-20°C to +60°C
Enclosure protection:	IP44, IEC EN60529
Immunity to electromagnetic fields:	3V/m EN61000-4-3
Immunity to ESD:	4 kV contact discharge and 8kV air discharge (EN61000-4-2)
Free fall test, standard product:	IEC 60068-2-32, procedure 1, dropped 12 times from 1 metre. Aastra approves 12 drops from 1.5 metre.
<i>Option</i>	
Bluetooth radio:	add-on from factory
Radio spectrum:	ISM 2.4000-2.4835 MHz
Bluetooth QD ID:	B014317
<i>Compliance to European regulations and standards</i>	
EU directives:	1999/5/EC (R&TTE)
Product marking:	CE
DECT Radio:	EN 301 406, TBR22
SAR (Specific Absorption Rate)*:	EN50360
Safety:	EN60950-1
EMC:	EN301489- 6, EN 301 489-1
<i>Compliance to US regulations and standards</i>	

Product marking:	FCC ID: BXZEICA  US: 9FVW4NANEICA HAC
SAR (Specific Absorption Rate):	FCC/OET Bulletin 65 Supplement C (2001) and IEEE Std. 1528-2003, December 2003 / ANSI/IEEE Std. C95.1-1999 Normal operation X W/kg (X gram) Body worn operation X W/kg (X gram)
Safety:	IEC 60950-1
EMC/Radio:	FCC Part 15 D
Hearing Aid Compliance:	47 CFR Part 68, Subpart D and TIA-968-A
<i>Compliance to Canadian regulations and standards</i>	
Product marking:	IC:3724C-xxxx
EMC/Radio:	RSS-210
Safety:	IEC 60950-1
SAR (Specific Absorption Rate):	IEEE Std C95.3-1999 Normal operation x.xxx W/kg (1 gram) Body worn operation x.xxx W/kg (1 gram)
Hearing aid:	CS-03
<i>Compliance to Australian regulations and standards</i>	
Product marking:	 
Radio:	According to ENxxxxxx
Safety:	IEC xxxxx-x
EMC:	xxx
SAR (Specific Absorption Rate):	ENxxxxx, x.xx mW/g

(1) Stand-by time is without activated screen saver

(2) Storing Li-Ion batteries at high temperature dramatically reduces their capacity. For example, storage at maximum temperature reduces capacity with 20% within a month.

## 21.5 Spare parts and Accessories

Use only approved spare parts and accessories. The operation of non-approved parts cannot be guaranteed and may even cause damage. Contact your supplier for more information.

- Leather case
- Swivel type clip
- Security chain
- Desktop Charger, Basic
- Desktop Charger, Advanced
- Charging Rack
- Separate battery charging (BCP)
- Headset with microphone on cable, DTX-9016
- Headset with microphone on boom, DTX-9017
- Bluetooth Headset (10 supported)
- CPDM



# 22 Troubleshooting

This section contains information on how to solve common operational problems, and warnings you may receive. Go through the following lists if you encounter any problems. If this checklist does not solve the problem, contact your system administrator. If others have similar problems, there may be a system error.

Table 2 Troubleshooting

<i>Fault</i>	<i>Probable cause</i>	<i>Action or comment</i>
No display	The battery level is low or the phone is defective.	Charge the battery or contact system administrator.
No ringing	The sound off icon is on, or ringer volume set to silent, or the telephone is defective.	Long press on  , or increase volume, or contact system administrator
“Connect battery” is displayed	Battery not properly fit or defect	Check battery or contact system administrator
Signal strength icon off	Out of system coverage area or the phone is defective.	Enter coverage area or contact system administrator.
Low battery icon on	Battery capacity equal to 10%	Charge battery
Low battery icon flashes	Battery capacity equal to or lower than 5%	Charge battery
4 short beeps every 2 minutes	Out of coverage area or not connected	Enter coverage area or contact system administrator
“Phonebook Full” is displayed	Phonebook full, you cannot add names or numbers	Delete a name and a number
“Enter XXX” is displayed (where XXX=IPEI or PIN)	IPEI code or PIN code	Enter required IPEI code or PIN code
“No access” is displayed	Network in range, but no access rights	Switch telephone off and then switch it on again or contact system administrator.

"NO NETWORK" is displayed	Cannot connect to selected network or out of range	Select another network, subscribe, get back within range or contact system administrator
No system The telephone beeps once a minute (during max 30 minutes) with a low tone followed by a high tone (if enabled, the vibrator also follows the beeps).	The telephone is out of coverage or telephone is defective.	Stop the beep with  and go into range. When reentering the coverage area it can take a couple of minutes before the telephone automatically has registered into the system.
SERVICE NEEDED <sup>(1)</sup> Parameters corrupt	The telephone is defective.	Select reset option on the middle soft key if available or if no reset option is available or fault does not resolve the telephone needs repair.
Enter PIN code	The telephone's lock is activated.	Enter the required PIN code. If PIN code lost enter new via PDM or do a factory reset via PDM.
"PIN Blocked Unblock?" is displayed	Phone blocked, wrong PIN code entered three times	See Section 2.4 on page 10
Phonebook is not available at the moment.	The phonebook does not respond, not available at the moment.	Try again later. If fault persists, contact your system administrator to do a factory reset.
Voice mail number not defined	There is no Voice mail number defined in the telephone.	Define a Voice mail number via PDM.
No headset found	Headset is turned off	Turn on headset
	Headset is turned off	Charge headset
	Headset is out of range	Move headset closer to phone
	Headset is not in pairing mode	Turn headset into pairing/ discoverable mode (see headset manual for details)

Pairing fails	Headset is not in pairing/ discoverable mode	Turn headset into pairing/ discoverable mode (see headset manual for details)
	Incorrect PIN entered	Try again and enter correct PIN (see headset manual for details)
Connecting fails/Failed to connect headset	Headset is not turned on	Turn on headset
	Headset is out of range	Move headset closer to phone
	Link key in headset has been deleted	Repeat pairing procedure
	Headset is already connected to another phone	Disconnect headset from the other phone
	Too close to a WLAN area and headset is not supporting Bluetooth standard v1.2	Shut down WLAN equipment
Headset can not connect to phone (see headset manual for details on how to connect)	Phone is not turned on	Turn on phone
	Phone is out of range	Move phone closer to headset
	Bluetooth module is disabled	Enable Bluetooth chip in Bluetooth menu
	Another headset is already connected to the phone.	Disconnect the connected headset
	Link key is missing in either headset or phone.	Repeat pairing procedure
	Too close to a WLAN area and headset is not supporting Bluetooth standard v1.2	Shut down WLAN equipment

(1) This display message is only shown in English.

Contact your system administrator if one of these error messages is displayed:

- System List Error

- Buzzer Data Error
- User Data Error
- User Phonebook Error
- Error xx (where xx = any number)

## 23 Glossary

This section gives a list of frequently used terms.

*Table 3*

Ac	Authentication code.
Abbreviated number	Short number. Initiating a call to a pre-programmed number by dialling a code or pressing a key.
Conference	If you have an ongoing conversation you can include other persons and establish a telephone conference.
DECT/GAP	Digital Enhanced Cordless Telecommunication/ Generic Access Profile. This means that no one can eavesdrop on your calls and that the quality of speech is as good as that of conventional fixed telephones. DECT/GAP enables interoperability with other manufacturers' products.
Directory number	Number with 1-8 digits which is assigned to an extension or external line or as a common abbreviated number.
DTMF tone	Dual Tone Multi Frequency or touch tone, for dialling.
Exchange	Switch. Your telephone switching system.
Extension number	All telephones connected to the PBX have a unique internal number (up to 8 digits). You can see your number on the display.
GAP	Generic Access Profile, a standard for cordless telephone systems.
Idle mode	The state your phone is in when nothing is activated.
IP call	Internal call sent through an internal data network (LAN or WAN).
IPEI Code	International Portable part Equipment Identity, a unique identity assigned to your phone by the manufacturer.

ISDN	Integrated Services Digital Network. Provides your system with supplementary services from the public net.
Least Cost Routing	A function that automatically selects the cheapest way to connect your external call.
Li-Ion battery	A battery made from Lithium ions. Li-Ion batteries are light-weight and have a very high energy density. This makes them ideal for use in portable equipment, such as cordless phones.
Park	Portable Access Right Key, unique identity assigned to your network.
PBX	Private Branch Exchange. Your telephone switching system (for example. MD Evolution Communication Platform).
PIN Code	Personal Identification Number for security.
Speed dialling number	Abbreviated number or short number, used for making frequently used numbers faster to dial.
SW	You can see which version of the phone software you have.
Tandem configuration	The tandem configuration is a unit consisting of two phones using the same directory number.
Third party	A third connection (person), which can be included in an ongoing two person conversation. The connection can be internal or external. See Section 9 on page 45.

Contact your system administrator if one of these error messages is displayed:

- System List Error
- Buzzer Data Error
- User Data Error
- User Phonebook Error
- Error xx (where xx = any number)

## 24 Telephony Function Codes

This section describes the country specific function codes that are relevant for the DT690 phone used in the BusinessPhone environment.

Service codes are activated with \* *service code #*, and deactivated with # *service code #*.

*Table 4 Standard and Alternative Codes*

<b>Function</b>	Standard	Alternative
Alternation on Inquiry	N/A	Sweden: R
Conference	3	
Intrusion	8	Austria: 4 Belgium: 4 Brazil: 4 Denmark: 4 Germany: 4
Call Waiting Indication	4	Austria: 5 Belgium: 5 Brazil: 5 Denmark: 5 Germany: 5 France: 6 New Zealand: 6
Call Back	5	Austria: 6 Belgium: 6 Brazil: 6 Denmark: 6 Germany: 6
Common Parking or Individual Call Pick-up	6	Austria: 8 Belgium: 8 Brazil: 8 Denmark: 8 Germany: 8 France: 4 New Zealand: 4
<b>Service Codes</b>		
General Deactivation	001	North America: 0
Choice of Language	08	
Ordering or Cancellation of Active List (Personal Number)	10	
Follow Me	21	

External Follow Me	22	North America: 23
Ordering or Cancellation of Interception Message	23	North America: 24
Print Interception Message	26	Sweden: N/A
Manual Message Waiting	31	
Cancellation of Message Waiting	31	North America: 56
Automatic Call Back, Cancellation	37	North America: 6
Malicious Call Tracing	39	
Calling Line Identification Restriction Per Call	42	
By-pass of Diversion	60	North America: 1
Account Code Predialing	61	Finland: 71 Norway: 71
Authorization Code Predialing	72	Germany: 75 The Netherlands: 75 North America: 6 Sweden: 75
Lock/Unlock Common Authorization Code	73	North America: 71
Change Individual Authorization Code	74	
Dial With Individual Authorization Code	75	Germany: 72 The Netherlands: 72 Sweden: 72
Lock/Unlock Individual Authorization Code	76	
Customer Identity Storage	77	
Answer on Group Call Pick-up, and Answer on Night Time Connection (* and # in the service code can be excluded)	8	Finland: 0 North America: 59 Sweden: 0
Ordering of Night Time Connection	84	North America: 8
Repetition of the Last External Number Dialed	***	Finland: **0 Sweden: **0
<b>Conference</b>		
Maximum number of parties when external lines are connected	8	

Maximum number of parties in a conference	8	
Maximum number of public trunk lines in a conference	8	North America: 6
Maximum number of external lines in a conference	8	North America: 6
<b>PBX Operator Service Codes</b>		
Selection of a specific line within a route	0	North America: 3
Conference	3	North America: 4
Day/night status for the exchange	80	
Emergency switching	90	